

ISO9001 CE CB UL

浙江思美克电力设备有限公司

ZHEJIANG SMICO ELECTRIC POWER EQUIPMENT CO.,LTD.

地址:中国·浙江省乐清市北白象白塔王工业区开创路376号
ADD: NO.376 Kaichuang Road,Baitawang Industrial
Zone Beibaixiang,Wenzhou,Zhejiang,325603 CHINA

电话(TEL):0086-577-62997327 55770567

传真(FAX):0086-577-62991338

WhatsApp/Wechat:+86 13968775537

Http://www.cnsmico.com

E-mail:cnsmico@cnsmico.com

cnsmico@hotmail.com

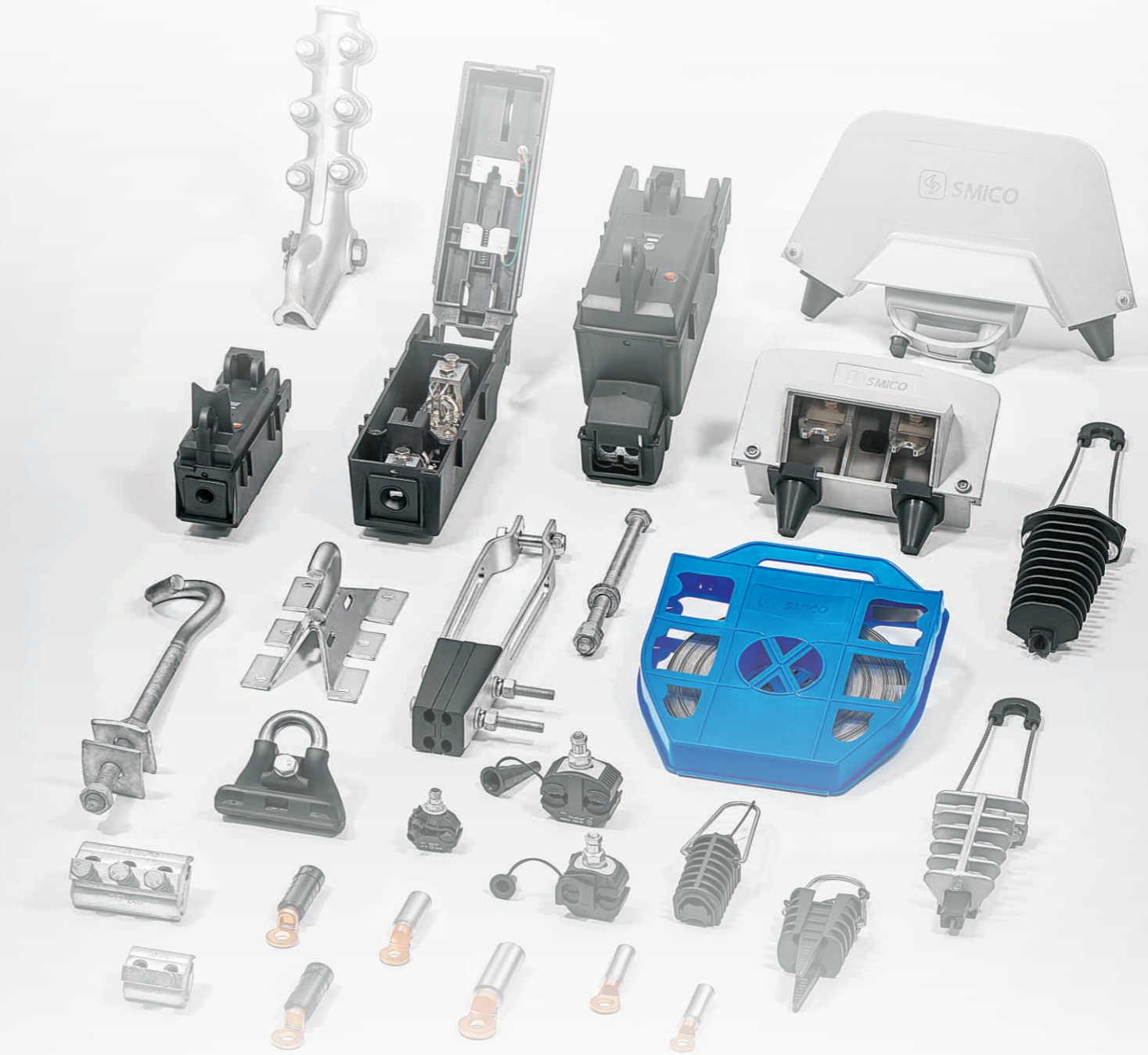

Top Supplier For Aerial Electrical Fittings...

浙江思美克电力设备有限公司

ZHEJIANG SMICO ELECTRIC POWER EQUIPMENT CO.,LTD.

INTRODUCTION

[Http://www.cnsmico.com](http://www.cnsmico.com)

Zhejiang Smico Electric Power Equipment Co.,Ltd. located in Liushi Town, Yueqing City, the China Electrical City. Have conveniently traffic,25km respectively from Wenzhou airport and railway station, and 5km from 104 national road freeway.

We specialized in manufacturing Aerial electrical fittings, Cable and wire terminal, Power connectors, Tools. Since we founded, we insisted to carry on the strategy to provide the top quality products, competitive price, perfect after-sale service, prompt new products developing to satisfy customers' demand. Therefore, our products have gained a strong reputation throughout the Europe, North American, South American, Middle East, and Southeast Asia, etc.

As we strive to hold on our promise of "Human Oriented, Technology Advanced", we make hard effort to increase our global market presence. We strictly produce the goods accordance with the ISO 9001, and most of our products have the CE and CB certificate.

We will improve ourselves all the time and sincerely invite you who interested in our products to develop the business together. We are always your electrical friends.



Company certificates



Contents

A

01-57
AERIAL ELECTRICAL FITTINGS

B

58-75
CABLE AND WIRE TERMINALS

C

76-80
POWER CONNECTORS

D

81-90
TOOLS

E

91-97
CUTOUT FUSE, INSULATOR, ARRESTER

A

AERIAL ELECTRICAL FITTINGS



ANCHORING BRACKET	ANCHORING CLAMP	FUSE SWITCH DISCONNECTOR	SUSPENSION CLAMP	PRE-INSULATED SLEEVE	PRE-INSULATED BIMETAL LUG	FIXING NAIL	ANCHORING CLAMP	FIXING STEEL BELT	INSULATED PIERCING CONNECTOR	INSULATED PIERCING CONNECTOR (LIGHTING)	INSULATED PIERCING CONNECTOR (TRANSFORMATION)



General of insulation piercing connector(IPC)

- 1.1 Piercing connector, simple installation, need not strip the cable coat.
- 1.2 Moment nut, piercing pressure is constant, keep good electric connection and make no damage to lead.
- 1.3 Self-seam frame, wetproof, waterproof, and anti-corrosion, extend the using life of insulated lead and connector
- 1.4 Adopted special connecting tablet, apply to joint of Cu(Al) and Cu(Al) or Cu and Al
- 1.5 Small electric connecting resistance, connecting resistance less than 1.1 times of the resistance of branch conductor with the same length.
- 1.6 Special insulated case body, resistance to illumination and environmental aging, the insulation strength can up to 12KV
- 1.7 Arc surface design, apply to connection with the same(different) diameter, wide connection scope(0.75mm²~400mm²)

(Performance testing)

- 2.1 Mechanical performance: the grip force of the wire clamp is 1/10 bigger than the break force of the lead. It comply with GB2314-1997
- 2.2 Temperature rise performance: under the condition of big current, the temperature rise of connector is less than that of connection lead.
- 2.3 Heat circle performance: conforms to GB/T2317.3-2000, the heat circle trial standard for electric fitting.
- 2.4 Waterproof insulation performance: conforms to the relevant requirements in Part 2 of GB/T13140.4-1998,
- 2.5 Resistance to corrosion performance: under the condition of SO₂ and salt fog, it can do three times of fourteen days circle testing.
- 2.6 Environmental aging performance: under the circumstance of ultraviolet, radiation, dry and moist, expose if with change of temperature and heat impulse for six weeks.
- 2.7 Fire-proof performance: insulation material of the connector withstands glowing filament test. Conform to the requirements in Chapter4-10 of GB/T5169.4



Insulation Piercing Connectors(IPC)



Special nut and moment nut

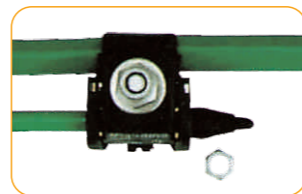

Appearance diagram of installation

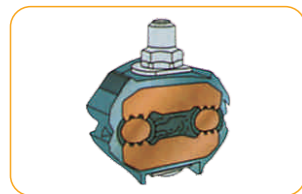

Section diagram of piercing effect



Piercing effect of insulated coat



Piercing effect of wire core

(Simple installation)

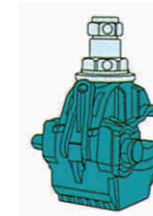

Adjust the connector nut to suitable location.

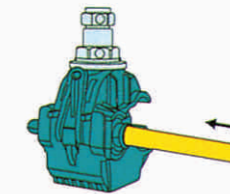

Put the branch wire into the cap sheath fully.

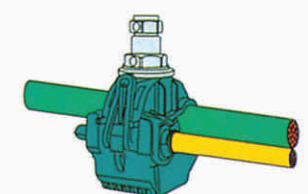

Insert the main wire, if there are two layers of insulated lay in the main cable, should strip a certain length of the first in length of the fist insulated lay from inserted end.

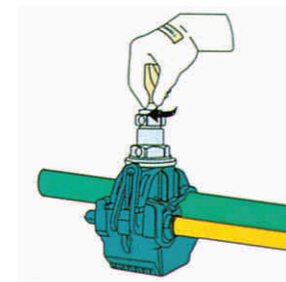

Turn the nut by hand, and fix the connector in suitable location.

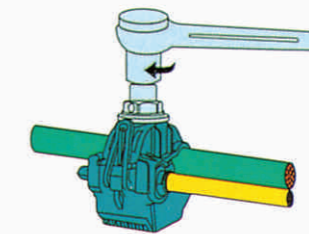

Screw the nut with the sleeve spanner.

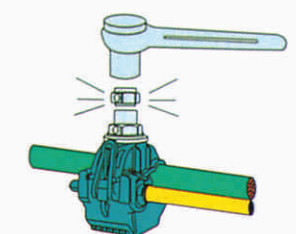

Screw the nut continually until the top part is cracked and dropped down.

The reason of choosing insulation piecing connector (IPC)

3.1 Simple installation

Can be branch of cable without stripping the insulated coat and the joint is completely insulated. Make branch in the random location of cable without cutting off the main cable. Simple and reliable installation, just need sleeve spanner, can be installed with on live line.

3.2 Safe use

The joint has good resistance to distortion, quake, fire, wet, electrochemical corrosion and aging, need no maintenance. Has been used successfully for 30 years.

3.3 Economical cost

Small installation space, save the cost of bridge and land construction. In structural application, there need no terminal box, junction box and return wire of cable, save cable cost. The cost of cables and clamps is lower than other power supply system.



Insulation piercing connectors



SMEP



SM2-95



SM3-95

Product type and application scope

1KV Series products (Low voltage series)

Model	Main line section	Branch section	Nominal current	Outline size	Weight	Piercing depth
SM756	0.75-6	0.75-6	41	21×27×23	10	1-1.5
SM041	6-10	1.5-6	41	26×39×54	85	1.5-2
SM101	1.5-2.5	1.5-10	55	27×41×62	55	1.5-2
SMEP	16-95	1.5-10	55	27×41×62	55	1-2
SM2-95	16-95	4-35(50)	157	46×52×87	160	1.5-2
SM2-150	50-150	6-35(50)	157	46×52×87	162	1.5-2.5
SM3-95	25-95	25-95	214	50×61×100	198	1.5-2
SM4-150	50-150	50-150	316	50×61×100	219	1.5-2.5
SM6	120-240	25-120	211	52×68×100	360	1.5-2.5
SM7	150-240	10-25	102	52×68×100	336	1.5-2.5
SM240	95-240	95-240	425	83×130×130	1040	1.5-2.5
SM300	300	ANY	425	83×130×130	1040	1.5-2.5
SM400	400	ANY	425	83×130×130	1040	1.5-2.5



JBC-1



JBC-2



JBC50-240

Model	Conductor Range(mm ²)		No.Bolt
	Main	Tap	
JBC-1	35-70	6-35	1
JBC-2	35-150	35-150	1
JBC50-240	50-240	50-240	2

Insulation piercing connectors



TT2D82F



IPC3.1



IPC3.2



IPC3.3



IPC3.4



TTD121F



TTD151F



TTD201F



TTD281F



TTD451F

Model	Conductor Range(mm ²)		No.Bolt
	Main	Tap	
IPC3.1	16-95	10-25	1
IPC3.2	70-95	70-95	1
IPC3.3	120-185	16-25	1
IPC3.4	70-185	70-185	2
TTD121F	25-95	2.5-25	1
TTD151F	25-95	(2.5)6-35	1
TTD201F	35-95	25-95	1
TTD281F	50-185	6-35	1
TT2D82F	25-95	25-35	1
TTD451F	95-240	95-240	2



DCNL-1



DCNL-2



DCNL-3



DCNL-4D

Model	Conductor Range(mm ²)	
	Main (Al/Cu) (mm ²)	Tap (Al/Cu) (mm ²)
DCNL-1	10-95	1.5-10
DCNL-2	16-95	4-35
DCNL-3	25-120	25-95
DCNL-4	50-150	4-35
DCNL-5	35-150	35-150
DCNL-1D	10-95	1.5-10
DCNL-4D	50-150	4-35

Insulation piercing connectors



Mode	Conductor Range(mm ²)	
	Main	Tap
CT-1	6-95	1.5-6
CT-2	6-150	2.5-25
CT-3	6-150	4-35
CT-4	25-150	25-95
CT-5	25-150	16-95



Mode	Conductor Range(mm ²)	
	Main	Tap
YN-1	6-25	6-25
YN-2	35-70	6-25
YN-3	35-70	35-70
YN-4/2	35-70	35-70



Mode	Conductor Range(mm ²)	
	Main	Tap
ABS	25-70	6-35
SMMA-1	16-95	16-25
SMMA-2	70-95	70-95
SMHA	70-185	70-120
CPA	16-70	16-70
DP10	50-70	50-70

SMC Piercing connector (1kV)

Application

Application to branch connection and succession for 1kV insulated overhead distribution systems.

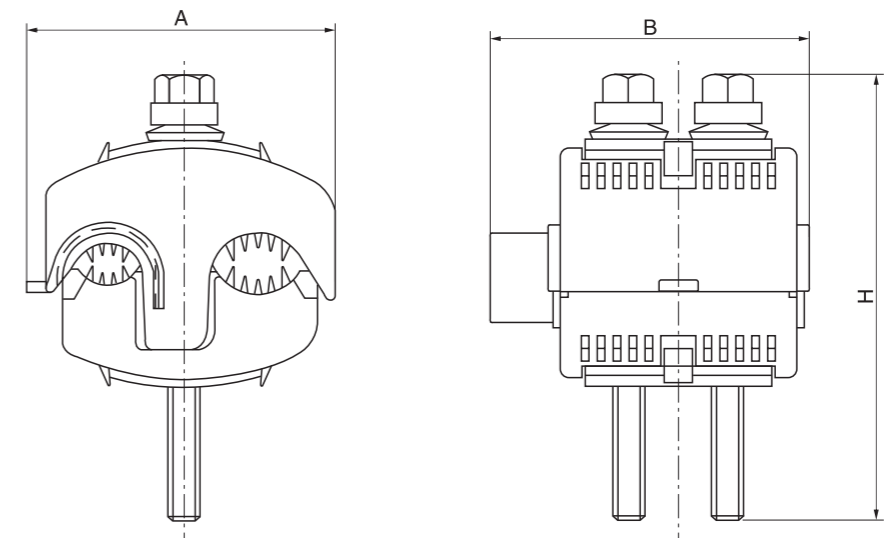
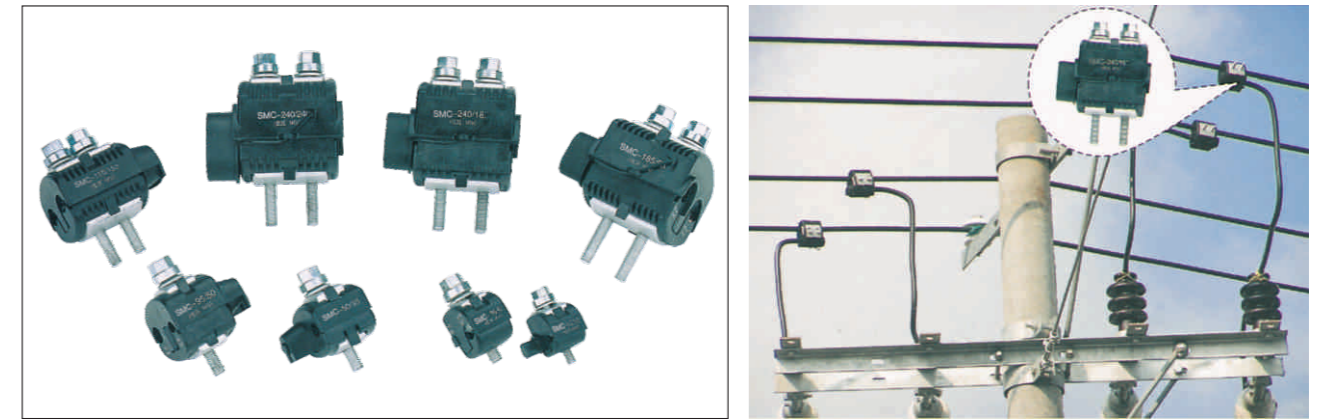

Technical Data

Mode	Applicable cable(mm ²)		Dimensions(mm)			Nominal Current(A)	Bolt No. (Piece)	Main application	Note
	Main line	Branch line	A	B	H				
SMC-150/150	35~150	35~150	65	53	87	342	2	The connection of main circuitries, the branch connection for main circuitries to house circuitries, electric appliances or street light.	Low-voltage double-insulation cable, available with the specifications of high-voltage piercing connector.
SMC-120/50	25~120	10~50	56	51	78	162	1		
SMC-95/50	25~95	6~50	54	51	78	162	1		
SMC-50/35	16~50	4~35	45	51	68	132	1		
SMC-95/10	25~95	1.5~10	37	25	58	75	1		
SMC-50/10	10~50	1.5~10	32	32	49	75	1		
SMC-240/240	95~240	95~240	90	85.5	113	476	2		
SMC-240/185	95~240	70~185	85.5	83	113	399	2		
SMC-240/50	150~240	16~50	76	83	113	162	2		
SMC-185/95	70~185	16~95	78.5	80.5	113	257	2		

SMC 10 Piercing connector (10kV)

Application

Application to branch connection and succession for 10kV insulated overhead distribution systems.

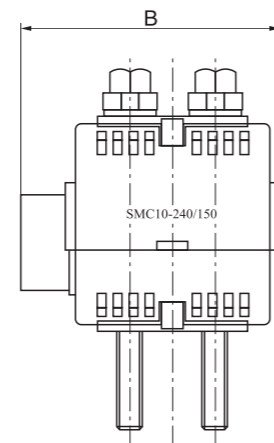
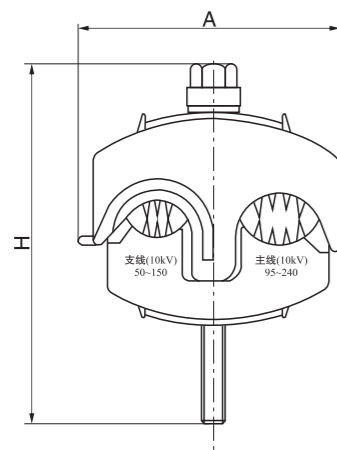
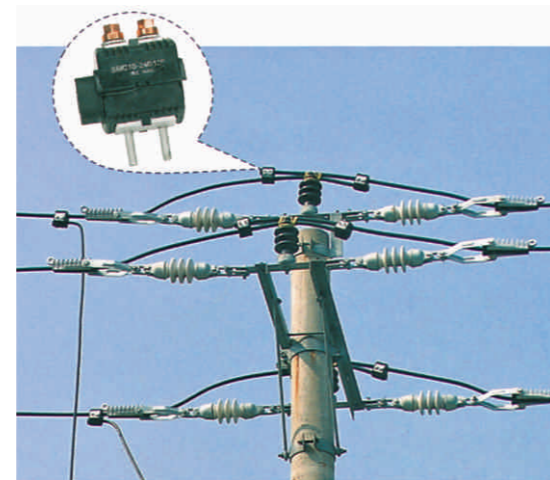
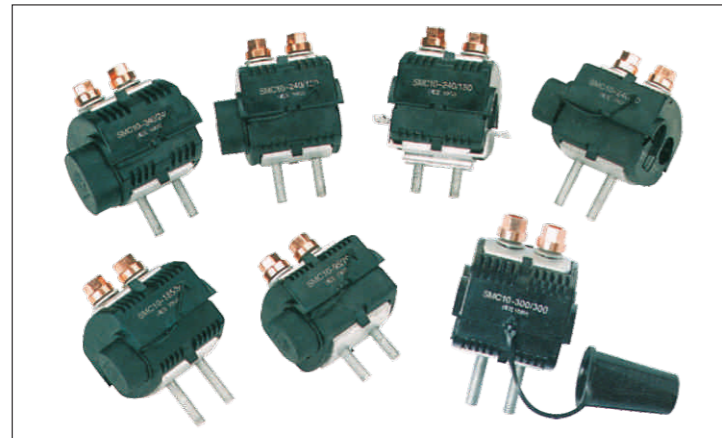

Technical Data

Modle	Applicable cable(mm ²)		Dimensions(mm)			Nominal Current(A)	Bolt No. (Piece)	Main application
	Main line	Branch line	A	B	H			
SMC10-300/300	150~300	150~300	100	85	136	600	2	The connection of main circuitries, the connection of main circuitry and branch circuitry.
SMC10-300/150	150~300	35~150	92	83	118	342	2	
SMC10-240/240	95~240	95~240	90	85.5	113	476	2	
SMC10-240/150	95~240	50~150	85.5	83	113	342	2	
SMC10-240/50	95~240	16~50	76	83	113	162	2	
SMC10-185/50	95~185	16~50	78.5	80.5	113	162	2	
SMC10-95/70	25~95	16~70	68	82.5	97.5	207	2	

SMC 20 Piercing connector (20kV)

Application

Application to branch connection and succession for 20kV insulated overhead distribution systems.

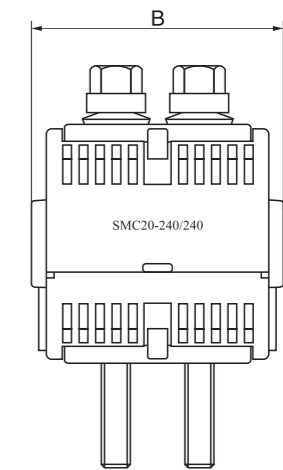
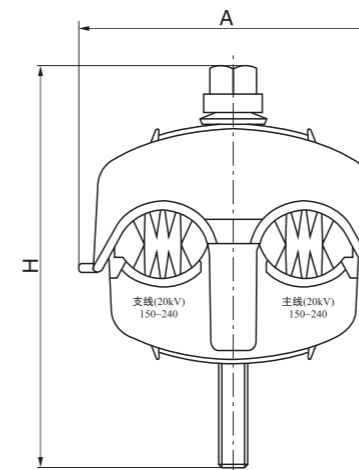
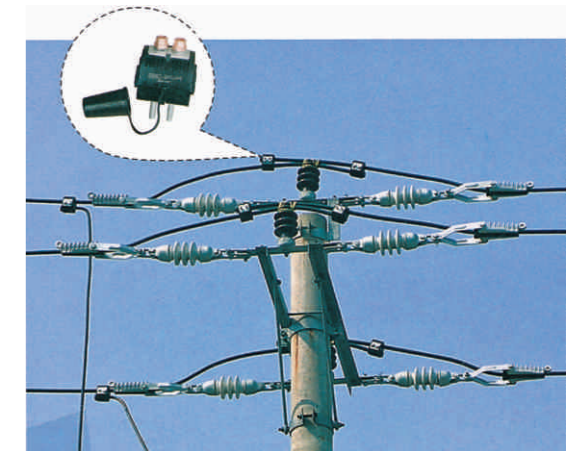
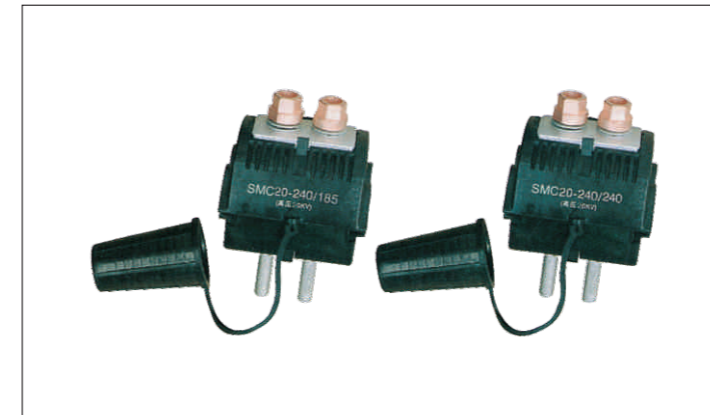

Technical Data

Modle	Applicable cable(mm ²)		Dimensions(mm)			Nominal Current(A)	Bolt No. (Piece)	Main application
	Main line	Branch line	A	B	H			
SMC20-240/185	95~240	50~185	100	91	141	399	2	The connection of main circuitries, the connection of main circuitry and branch circuitry.
SMC20-240/240	150~240	150~240	100	91	141	476	2	

SMCF Piercing grounding protection(1kV)

Application

Application to grounding protection during electric power construction for 1kV or below insulated overhead line.

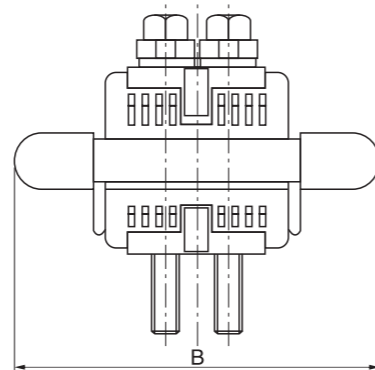
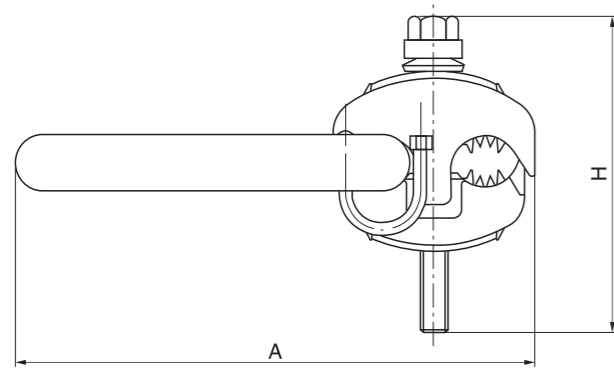

Technical Data

Modle	Applicable voltage(kV)	Applicable cable(mm ²)	Dimensions(mm)			Nominal Current(A)	Bolt No. (Piece)	Main application
			A	B	H			
SMCF-240/150	1	150~240	160	140	113	476	2	The grounded safety protection of main circuitry when electric power construction.
SMCF-185/95	1	95~185	158	140	113	399	2	
SMCF-120/35	1	35~120	152.5	106	87	299	2	
SMCF-95/16	1	16~95	139	88	78	257	1	

SMCF Piercing grounding protection(10kV)

Application

Application to grounding protection during electric power construction for 10kV or below insulated overhead line.

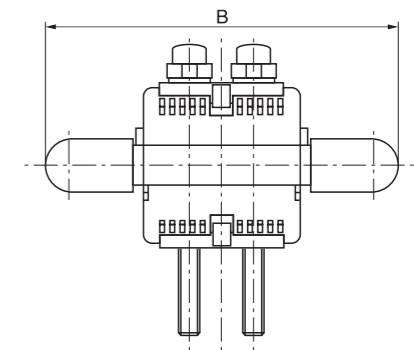
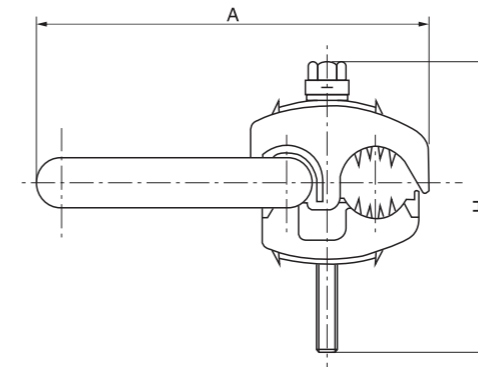
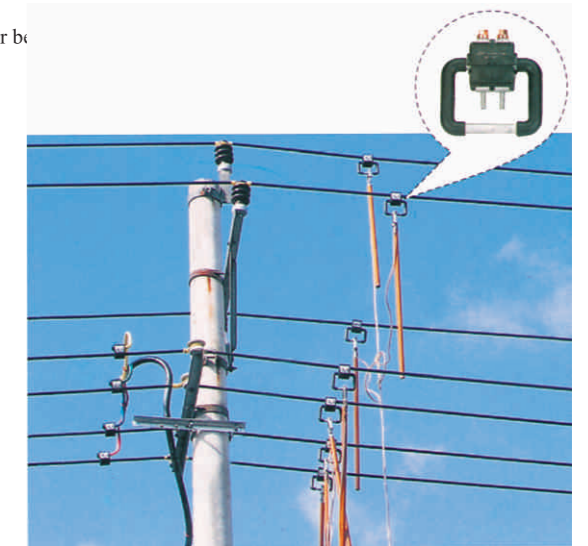

Technical Data

Modle	Applicable voltage(kV)	Applicable cable(mm ²)	Dimensions(mm)			Nominal Current(A)	Bolt No. (Piece)	Main application
			A	B	H			
SMCF10-300/150	10	150~300	167.5	140	118	600	2	The grounded safety protection of main circuitry when electric power construction.
SMCF10-240/150	10	150~240	160	140	113	476	2	
SMCF10-185/95	10	95~185	158	140	113	399	2	
SMCF10-95/25	10	25~95	148.5	140	98	257	2	

SMCF Piercing grounding protection(20kV)

Application

Application to grounding protection during electric power construction for 20kV or below.

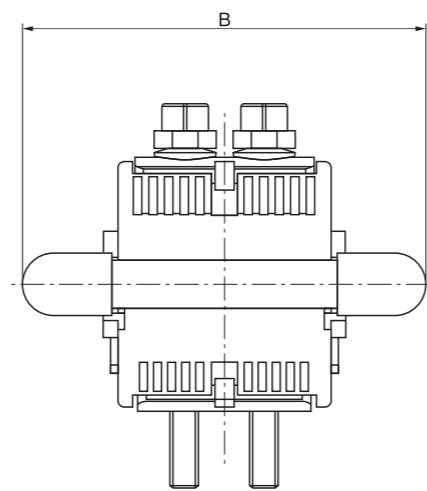
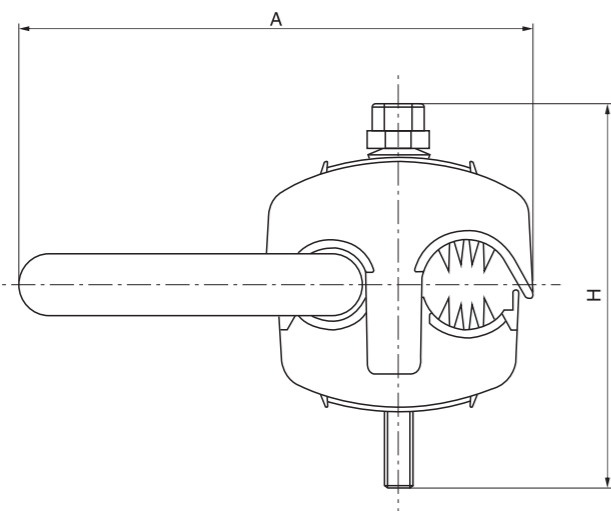
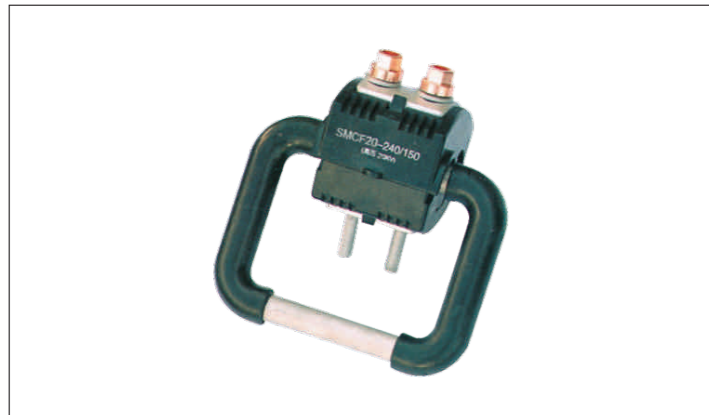

Technical Data

Modle	Applicable voltage(kV)	Applicable cable(mm ²)	Dimensions(mm)			Nominal Current(A)	Bolt No. (Piece)	Main application
			A	B	H			
SMCF20-120/35	20	35~120	166	140	123	299	2	The grounded safety protection of main circuitry when electric power construction.
SMCF20-240/150	20	150~240	170	140	140	476	2	

End cap



Material: Plastic
Product property: It is used to waterproof and insulate the end of the conductor(0.6/1kV).

Modle	Conductor Cross-section(mm ²)
PC6-35	6-35
PC35-70	35-70
PC70-95	70-95
PC95-120	95-120
PC120-185	120-185

Insulated piercing connector



Material: High strength aluminium alloy, anti-UV plastic

A broad usage in the low voltage insulation lines, leading the branch connection to the main conductor. T-connection of low voltage insulation wire service and cable branch connection for building distribution system. The material for the inside body is high strength aluminum alloy, and the insulation cover is used polyvinyl chloride(PVC). The connectors with specially designed contact teeth, are suitable for the connection of aluminum. Put the main conductor and branch conductor parallel into the teeth grooves of the clamp, tighten the bolts, pierce the insulation of two conductors to make the conductors connect.

The insulation cover functions as waterproof and sealing perfectly.

At the breaking force of the conductor, the connector will not be distorted and broken. At the rated current and short circuit, rising temperature of the connector should be less than the connecting conductor.

Modle	Main Conductor Cross-section(mm ²)	Tap Conductor Cross-section(mm ²)
PI-71	35-95	4-54
CD-71	35-95	4-54
PC-150	35-150	4-50
P-71	35-95	4-50
P-72	35-95	2×(4-50)
P-150	70-150	2×(4-54)
P-151	16-150	6-95

Insulated piercing connector

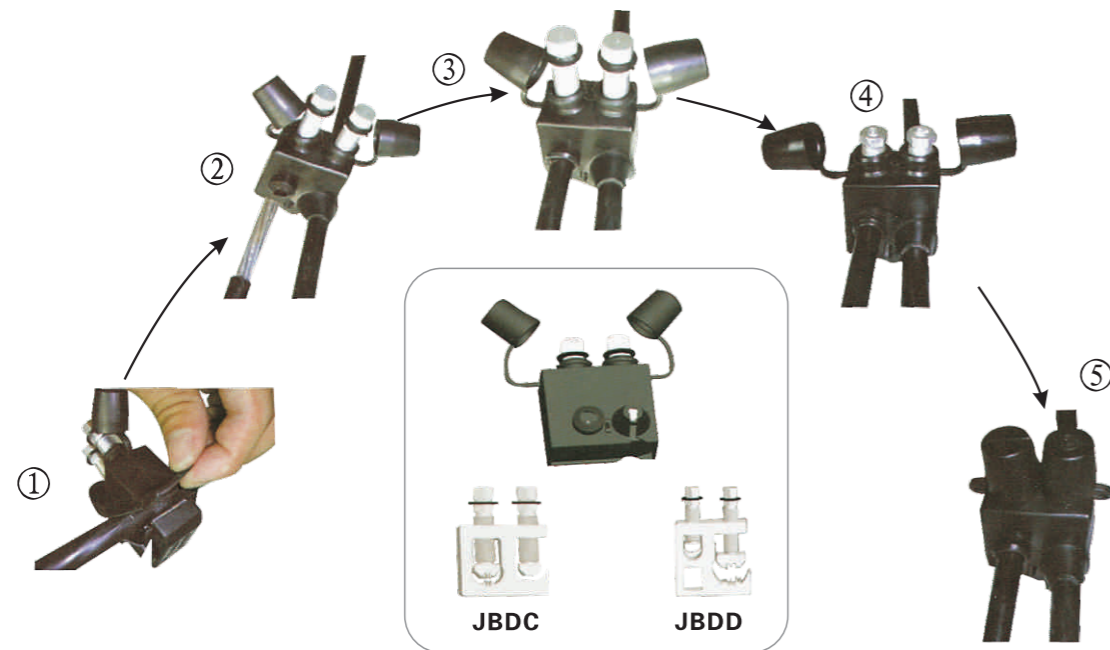

Material: High strength aluminium alloy, anti-UV plastic

Product property: JBDC and JBDD series products have more functions than JBD.

JBDC is to lead the branch from the bare main line, while JBDD is to lead the branch from the insulated main line. Tighten the bolt with an ideal torque, which ensures the best quality of connection.

Modle	Bare Main Conductor Cross-section(mm ²)	Insulated Branch Conductor Cross-section(mm ²)
JBDC6-35/6-35	6-35	6-35
JBDC50-150/6-35	50-150	6-35
JBDC50-150/35-95	50-150	35-95

Modle	Insulated Main Conductor Cross-section(mm ²)	Bare Branch Conductor Cross-section(mm ²)
JBDD6-35/6-35	6-35	6-35
JBDD50-150/6-35	50-150	6-35
JBDD50-150/35-95	50-150	35-95

Insulated piercing connector



SM35-P35



H1

Modle	Conductor range (mm ²)	Torque(N · m)	Insulator Endurance(6KV · 1min)	Ageing Test(salt spray)
SM35-P35	10-16	10	OK	OK
H1	16-35	10	OK	OK

Simple installation

I -INSTALLATION

- There is no need to adjust the pre-positioned shearhead bolts prior to assembly.
- If required,strip the conductor to the length specified on the connector.
- Begin the assemblywith the dead conductor.
- Insert each conductor fully along the axis of the connector.Hold the conductor in place whilst pre-tightening the shearhead bolts to locate the cable.

For Installation under load(max.90A)("RED" side only)

- Secure the connector with the 1st conductor installed,to the ABC bundle with tape or a cable tie.
- Secure the electrical contact between the stripped conductor and the end of the adaptor during the tightening.
- To complete the installation,tighten the shearhead bolt untill breaks off.

II-DISMANTLING "RED" SIDE ONLY

- The connector can be removed,off load,for the red side by use 2nd remaining hex head.
- To remove under load,cut the conductor approx,1 cm from the connector,using an appropriate cable cutter.Then lose the "red" screw and remove the remainingsection.
- Use the plug provided to reseal the connector.

III-REINSTALLATION"RED" SIDE ONLY

- Strip the conductor to the length specified on the connector.
- Insert the stripped end of the conductor into the connector,as instructed in section I.
- To complete the installation,tighten the hex head bolt to the torque level specified on the connector.

IV-CAUTION(SM35-P35)

- Care should be taken to ensure that the correctly prepared conductor is inserted into the correct end of the connector.
- "RED"load making sied for stripped conductor.
- "LACK"insulation piercing for un-stripped conductor.

Pre-insulated sleeve



MJPT

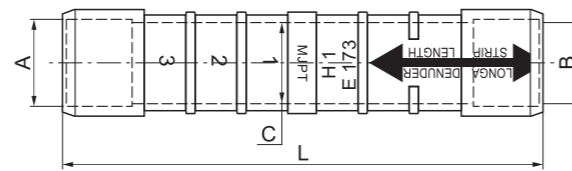

Modle	Cable Size (mm ²)		Plastic Sleeve Diameter(mm)	Length (mm)
	A	B		
MJPT 16/16	16	16	20	70
MJPT 25/25	25	25	20	70
MJPT 35/35	35	35	20	98.5
MJPT 50/50	50	50	20	98.5
MJPT 70/70	70	70	20	98.5
MJPT 95/95	95	95	25	135
MJPT 120/120	120	120	25	150

Material: Aluminum alloy

Product property: MJPT is designed to connect the insulated cable (include ABC cable) in aerial distribution network. It is in accordance with NFC33-021. The sleeve is with some tension.

And its cap can prevent the water into the barrel. It is colored differently to distinguish the cable sizes.

Marked with type, cable size, die size, inner cable length and number of crimping.

Pre-insulated sleeve



MJPB

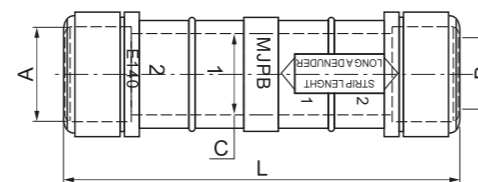

Modle	Cable Size (mm ²)		Plastic Sleeve Diameter(mm)	Length (mm)
	A	B		
MJPB 6/16	6	16	16	73.5
MJPB 10/16	10	16	16	73.5
MJPB 16/16	16	16	16	73.5
MJPB 16/25	16	25	16	73.5
MJPB 25/25	25	25	16	73.5

Material: Al-99.5%

Product property: MJPB is designed to connect the insulated cable (include ABC cable). It is in accordance with NFC33-021. The sleeve is without tension.

And its cap can prevent the water into the barrel. It is colored differently to distinguish the cable size.

Marked with type, cable size, die size, inner cable length and number of crimping.

Pre-insulated sleeve



MJPTN

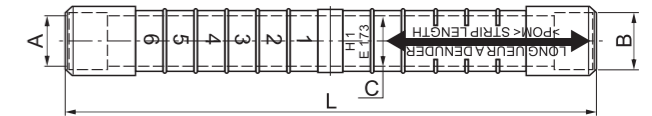

Modle	Cable Size (mm ²)		Plastic Sleeve Diameter(mm)	Length (mm)
	A	B		
MJPTN 54.6/54.6	54.6	54.6	20	172.5
MJPTN 54.6/70	54.6	70	20	172.5
MJPTN 70/70	70	70	20	172.5
MJPTN 95/95D	95	95	25	172.5

Material: Aluminum alloy

Product property: MJPTN is designed to connect the neutral messenger in aerial bundled cable. It is in accordance with NFC33-021. The sleeve is with full tension.

And its cap can prevent the water into the barrel. It is colored differently to distinguish the cable sizes.

Marked with type, cable size, die size, inner cable length and number of crimping.

Pre-insulated bimetal lug



CPTAU

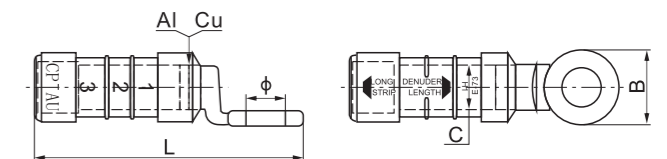

Modle	Dimensions(mm)			Length(mm)
	C	B	φ	
CPTAU 16-10	16	20	10.5	73
CPTAU 25-12	20	24	13	98.5
CPTAU 35-12	20	24	13	98.5
CPTAU 50-12	20	24	13	98.5
CPTAU 54.6-12	20	24	13	98.5
CPTAU 70-12	20	24	13	98.5
CPTAU 95-12	20	24	13	98.5
CPTAU120-12	23	30	13	125
CPTAU150-12	23	30	13	125
CPTAU180-12	32	35	13	145
CPTAU240-12	32	35	13	145

Material: E-Cu; Al-99.6%

Product property: CPTAU is designed to connect the insulated cable (include ABC cable). It is in accordance with NFC33-021.

The waterproof cap can prevent the water into the barrel. It is colored differently to distinguish the cable sizes.

Marked with type, cable size, die size, inner cable length and number of crimping.

Pre-insulated sleeve(with fuse)



MJPF

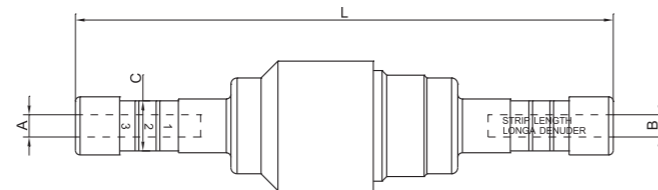

Modle	Cable Size (mm ²)		Plastic Sleeve Diameter(mm)	Length (mm)
	A	B		
MJPF 16/16	16	16	16.2	174.0
MJPF 16/25	16	25	16.2	174.0
MJPF 25/25	25	25	16.2	174.0

Material:Brass(silver plating) Aluminium

Product property: MJPF is designed to connect the neutral messenger in aerial bundled cable. It is in accordance with NFC33-021. The sleeve is with full tension.

And it's cap can prevent the water into the barrel. It is colored differently to distinguish the cable sizes.

Marked with type, cable size, die size, inner cable length and number of crimping.

Accessories

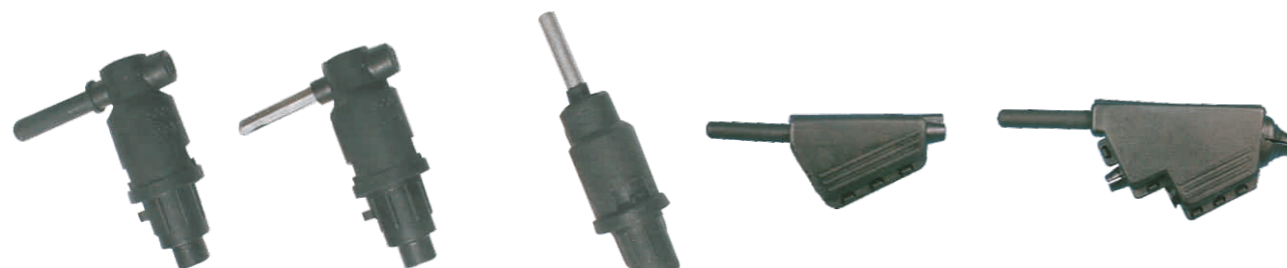

SDPA

SDPAD

SDPAV

SDCC

SDCC-R

Modle	Conductor Range(mm ²)	
	Type	mm ²
SDPA	Lateral isolation	-
SDPAD	Lateral skinned wire isolation	-
SDPAV	Vertical isolation	-
SDCC	Single	6/6
SDCC-R	Single	25/25
	Double	2 × 16+1 × 16

Anchoring bracket



SM81

SM82

SM83

Material: High strength aluminium alloy by casting
Product property: Anchoring ABC cables with neutral messenger on poles (wood, concrete etc.....), Excellent in industrial and saline environment. Fixed by 2 × (14mm or 16mm) bolts or 2 stainless straps 0.75 × 20mm. It is in accordance with NFC 33-040.



SM96

SM97

SM98

SM22

The universal hook SM96, SM97 and SM98 is used with bands in pole installations and with screws in wall installations. The hook is delivered without screws.

Anchoring clamp

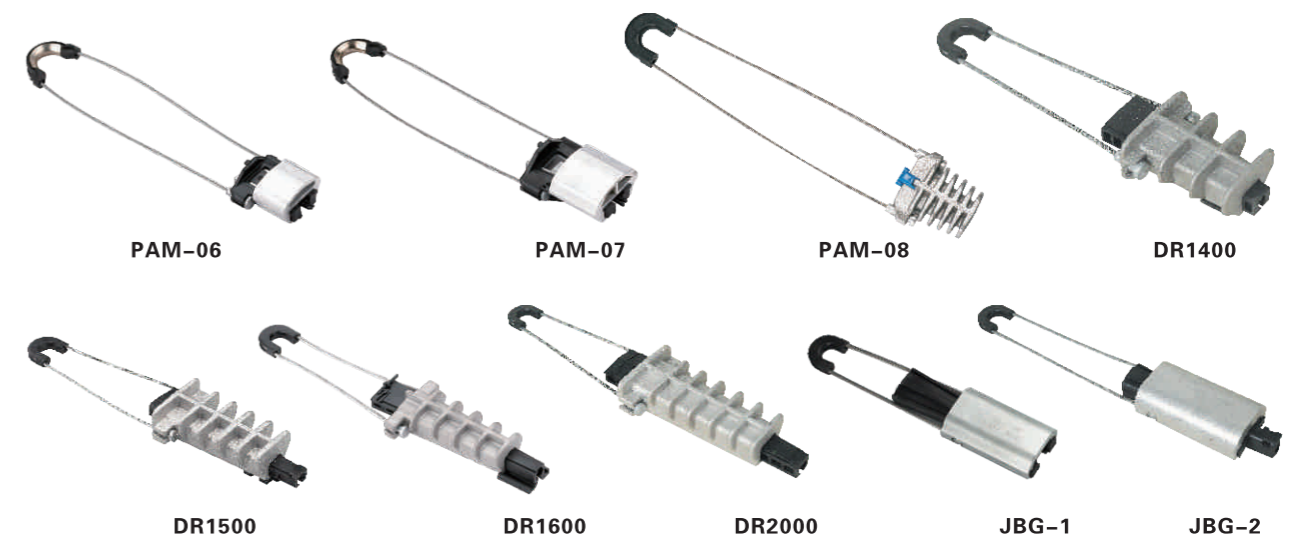

PAM-06

PAM-07

PAM-08

DR1400

DR1500

DR1600

DR2000

JBG-1

JBG-2

Material: High strength aluminium alloy, nylon plus fiber glass, stainless steel

Product property: They are characterized by high mechanical stability, reduced dimensions for easier handling, high mechanical and climatic resistance. Cable gripping device in insulating material ensures the double insulation of the neutral core and avoids damage to sheath, secured parts, no tools required. Stainless steel bail with two marbles compressed on the end, this conception allows an easier locking on the body of the clamp. They are in accordance with NFC 33-041.

Modle	Cross-section(mm ²)
PAM-06	16-20
PAM-07	16-25
PAM-08	16-25
DR1400	25-35
DR1500	35-70
DR1600	35-70
DR2000	70-150
JBG-1	35-70
JBG-2	50-95

Anchoring clamp



STA STB STC STD LA1



LA2 DCR-1 DCR-2 DCR-3



2.1 2.2 2.3 PA1500 PA2000

Material: Nylon plus fiber glass

Product property: They plastic anchoring clamp is suitable for insulated low-voltage ABC cable. It is also suitable for multiple conductors. Easy installation and perfect insulated function. It is in accordance with the NFC 33-042.

Mode	Cross-section(mm ²)
STA	1×10/1×16
STB	2×16/2×25
STC	4×16/4×25
STD	1×16/1×70
LA1	4×16/4×25
LA2	2×6/2×16
DCR-1	1×4/1×25
DCR-2	1×4/1×25
DCR-3	1×4/1×25
2.1	16-25
2.2	95-120
2.3	16-35
PA1500	25-50
PA2000	54.6-70

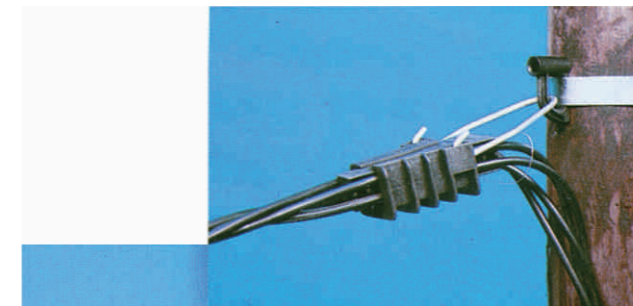

SKA-1

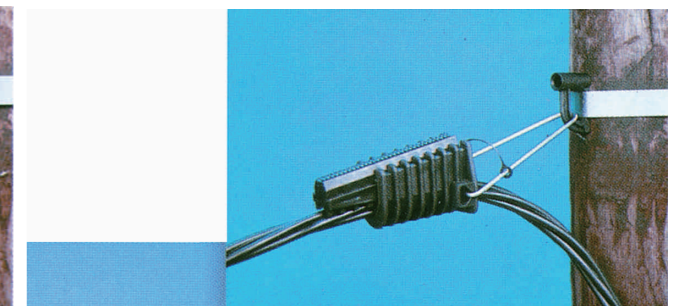

SKA-2

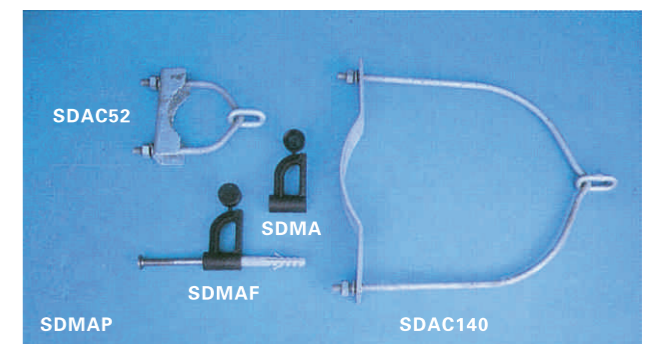
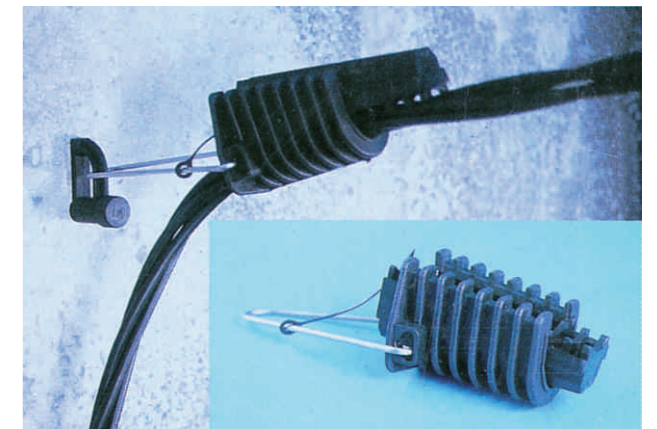
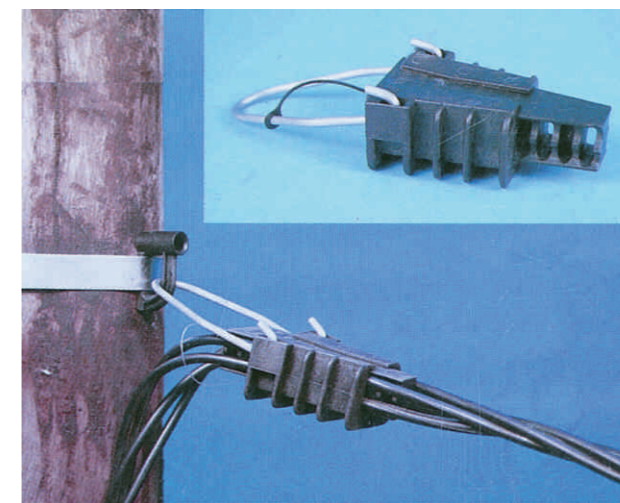
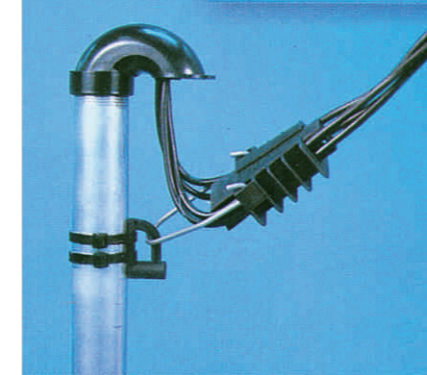

Anchoring clamp

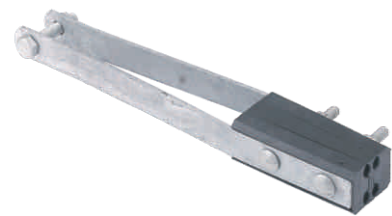

NES-B1



NES-B2



NES-B3

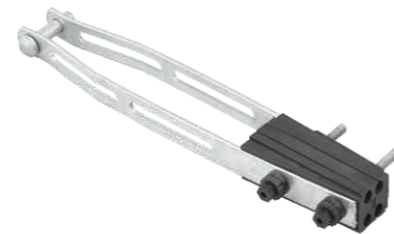

NES-B4

Material: Mild steel, nylon plus fiber glass

Product property: It is used to terminate 4-core of aerial bundle conductor. Its function is fixing and tightening the insulation conductor.

Mode	Conductor Cross-section(mm ²)
NES-B1	4×(16-35)
NES-B2	4×(50-120)
NES-B3	4×(25-120)
NES-B4	4×(95-150)

Anchoring clamp



SM116



SM117

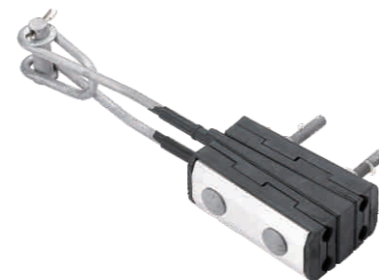

SM118

For the termination of 4-core LV ABC cable with hook fixing. The clamps have strong springs which keep the clamp in an open position during the installation of conductors. The clamping action functions through wedges. The body is made of weather resistant aluminium alloy and the plastic parts of special fibreglass reinforced plastic.

Mode	Conductor Cross-section(mm ²)
SM116	4×(25-35)
SM117	4×(50-120)
SM118	4×(50-120)

Anchoring clamp



SM156



SM157

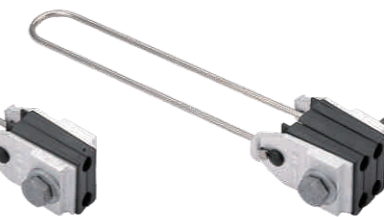

SM158

SM156, SM157 and SM158 used for the anchoring of a 2 or 4 core overhead cable to poles or walls by means of standard hooks.



SM160



SM161

Tension clamp for the anchoring of 2 or 4 core overhead cables to poles or walls by standard hooks. Tension clamp is equipped with a spring to make the installation easier.

Mode	Conductor Cross-section(mm ²)
SM156	4×(16-25)
SM157	2×(16-25)
SM158	4×(16-25)
SM160	2×(16-25)
SM161	4×(16-25)

Suspension clamp



SM130



SM140



SM136

Used for the installation and suspension of LV ABC cables to poles with standard hook attachment. For straight lines and angles up to 30° 4×(25-120 mm²) and 60° 4×(25-50). Thanks to the integrated construction, no extra parts are needed for the installation. The body is made of corrosion proof aluminium and the inserts of weather resistant plastic.

Light duty clamp for the installation and suspension of 4-core LV ABC cables to poles with standard hook attachment. For straight lines and angles up to 30° . Thanks to the integrated construction, no extra parts are needed for the installation. The body is made of corrosion proof aluminium and the inserts of weather resistant plastic.

For the installation and suspension of 4-core LV ABC cables to poles with standard hook attachment. For straight lines and angles up to 90° . No extra parts are needed for the installation.

Mode	Conductor Range
SM130	2-4× (25-50) ≤60° / 2-4× (25-120) ≤30°
SM140	2-4× (25-120) ≤30°
SM136	2-4× (25-120) ≤90°

NEJ Wedge strain clamps for insulation cable

Application

This series are mainly used in 20kV or less than 10kV distribution system to fix and tighten the aluminum insulating wires at the corner or the end of the insulators on the stilt.

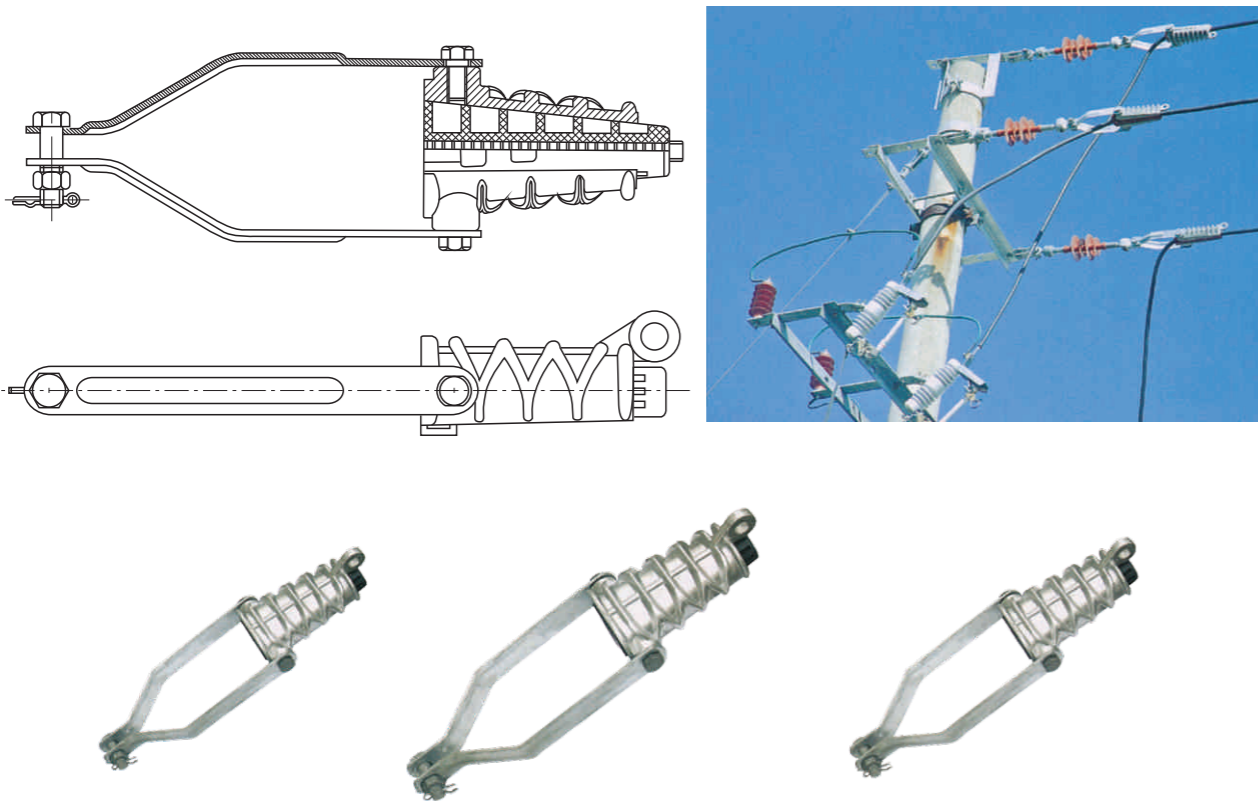

Technical Data

Modle	Applicable conductor(mm ²)			Inner clamping range	Grip strength(kN)	Failure load(kN)
	1kV	10kV	20kV			
NEJ-1	35	-	-	Φ10~Φ11	3.4	12.4
	50	16	-	Φ12~Φ13	4.6	
	70	25	-	Φ14~Φ15	6.7	
	95	35	-	Φ15~Φ17	8.9	
NEJ-2	120	50~70	25~35	Φ16~Φ18.5	11.3	20.8
	150	95	50	Φ19.00~Φ21	13.7	
NEJ-3	185	120	70	Φ21.0~Φ23	17.3	32.0
NEJ-4	240	150	95	Φ23~Φ25.6	22.5	41.7
		185	120	Φ24~Φ26	22.5	
		240	150	Φ26~Φ27.5	22.5	
NEJ-5		300	185~240	Φ27.5~Φ31.5	22.5	52.1
				Φ27.5~Φ31.5	28.2	

JNS Four(two)-core bunched cable strain clamp series

Application

JNS series four-core bunched cable strain clamp series are fully used for fixing or tightening 1kV and less than 1kV overhead four(two)-cores bunched cable at ends of circuit.

Function and Features

1. It adopts four(two)-core paralld groove paralld gap structure. Put the four insulation cables into clamp according to circuit design without peeling off the coat, then tighten the bolt to bunch it.
2. For inner block and filling pole with high strength, anti-climate resistance insulation plastic, it can be used for a long term;
3. Adopting wedge type self-tighten structure, after tightening the ring, it will be fixing, and get a quite big grasp strength.

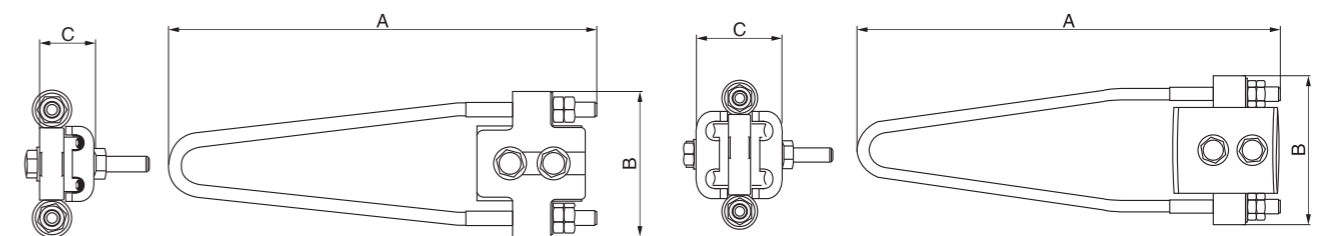
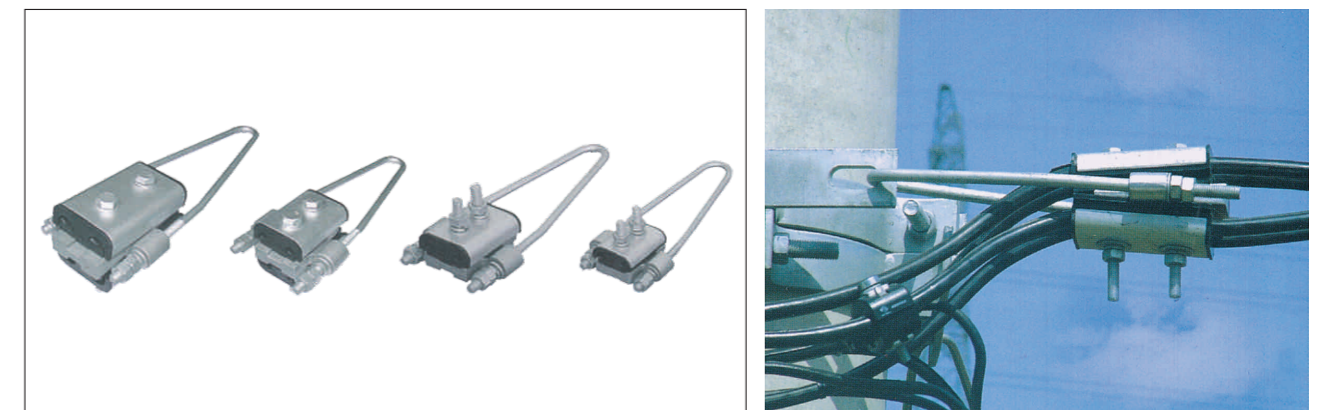

JNS two-core bunched cable train clamp series

JNS four-core bunched cable train clamp series

Technical Data

Modle	Applicable Voltage(kV)	Applicable conductor(mm ²)	Dimensions(mm)			Note
			A	B	C	
JNS-1A-1	1kV	4×10-4×16mm ²	200	78	45	Four cores
JNS-1A-2		4×16-4×50mm ²	260	100	62	
JNS-2A		4×50-4×120mm ²	330	105	72	
JNS-1C	1kV	2×10-2×16mm ²	200	78	30	Two cores
JNS-2C		2×16-2×50mm ²	260	100	40	

Suspension clamp



SM94

SM95

1.1A

1.1B



ES54-14

PS1500



SHC-1

SHC-2

SHC-3

SHC-5

SHC-6

SHC-7

Product property: On poles, in alignment or angle, different level, also provide for hanging a public light bundle.

Model	Conductor Range
SM94	16-95
SM95	16-95
1.1A	16-95
1.1B	16-95
ES54-14	16-95
PS1500	16-95
SHC-1	4×(16-35)
SHC-2	4×(50-120)
SHC-3	4×(50-70)
SHC-4	4×(50-70)
SHC-5	4×(70-95)
SHC-6	4×(70-95)
SHC-7	4×(10-25)

Fixing nail

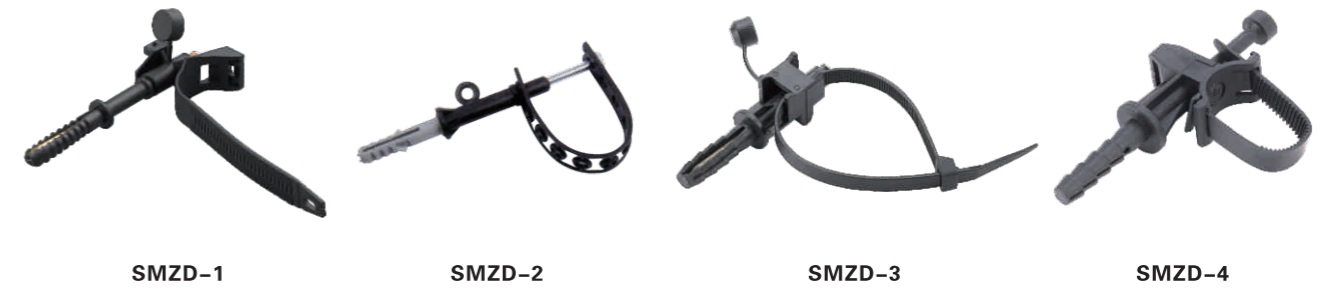

SMZD-1

SMZD-2

SMZD-3

SMZD-4

It is in accordance with NFC 33-040

Model	Conductor Range(mm)
SMZD-1	15-47
SMZD-2	12-47
SMZD-3	15-47
SMZD-4	15-30

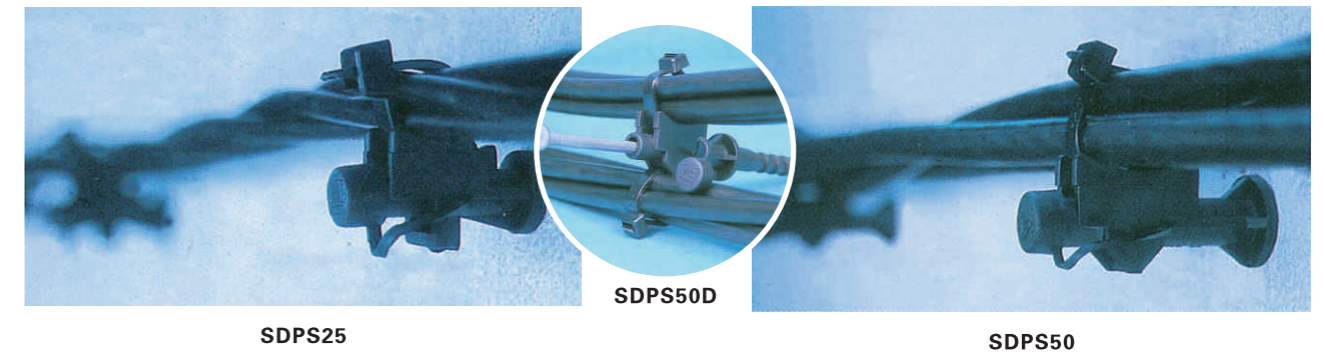

SDPS25

SDPS50D

SDPS50

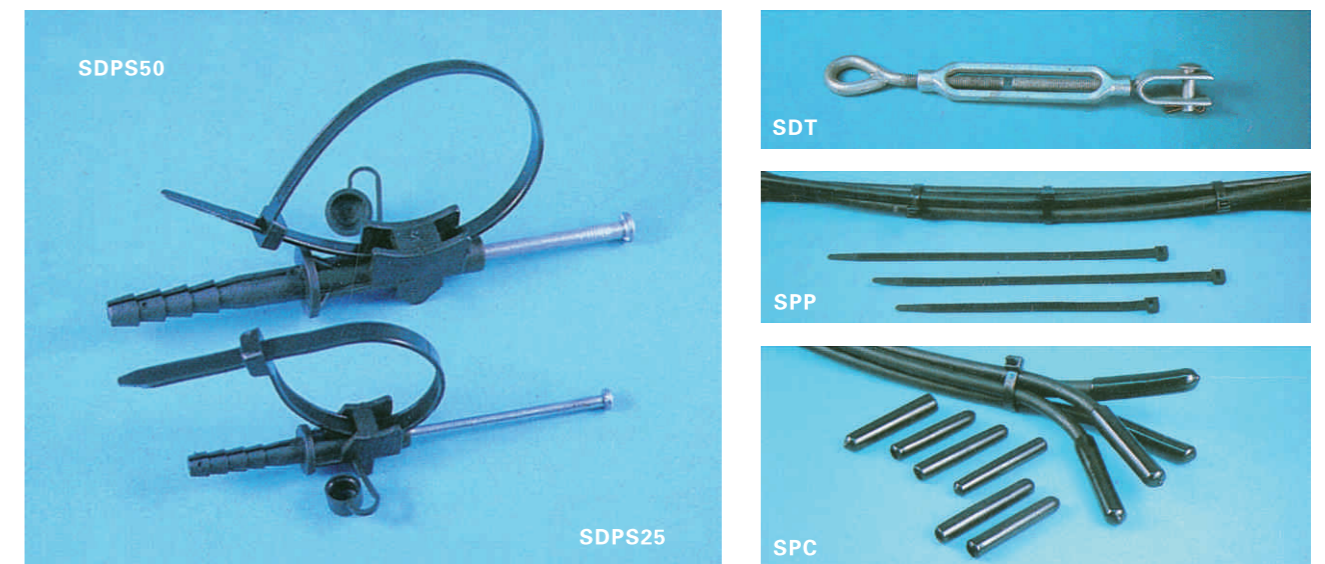

SDPS50

SDT

SPP

SPC

SDPS25

Type 304 Stainless Steel Band

1. Band and buckle can be quickly formed to suit virtually any diameter.
2. Applications include hose clamps, pipes, signs, cables, especially where superior strength is required.
3. Dispensers-Handy plastic dispensers available with centre turn facility and pocket for buckles.
4. Excellent corrosion resistance.



Portable Dispensers

Type 304 Stainless Steel

Modle	Width		Thickness		Weight	
	Im.	mm	Im.	mm	lbs	kg
SMB1450	1/4	6.35	0.020	0.50	1.76	0.80
SMB3850	3/8	9.53	0.020	0.50	2.64	1.20
SMB1276	1/2	12.70	0.030	0.76	5.50	2.50
SMB5876	5/8	15.88	0.030	0.76	7.04	3.20
SMB3476	3/4	19.05	0.030	0.76	8.27	3.76

Available in mill coil lengths. All size in standard cardboard packing.

Type 304 Stainless Steel

Modle	Width		Thickness		Weight	
	Im.	mm	Im.	mm	lbs	kg
SMBD3850	3/8	9.53	0.020	0.50	3.08	1.40
SMBD1276	1/2	12.70	0.030	0.76	5.94	2.70
SMBD5876	5/8	15.88	0.030	0.76	7.48	3.40
SMBD3476	3/4	19.05	0.030	0.76	8.71	3.96

Customers can assign different colors for different sizes.

Stainless Steel Buckle

Tooth type

Modle	For band width		Thickness
	Inch	mm	mm
SMBT14	1/4	6.35	0.8
SMBT38	3/8	9.53	1.0
SMBT12	1/2	12.70	1.2
SMBT58	5/8	15.88	1.2
SMBT34	3/4	19.05	1.5
SMBT1	1	25.40	1.8
SMBT114	1 1/4	32.50	2.0

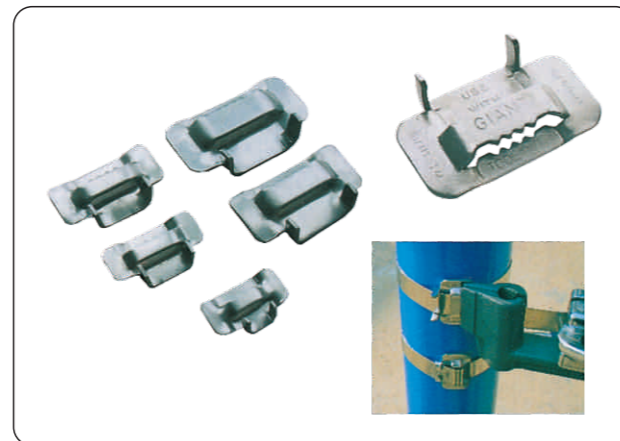

L type

Modle	For band width		Thickness
	Inch	mm	mm
SMBL14	1/4	6.35	0.6
SMBL38	3/8	9.53	0.7
SMBL12	1/2	12.70	0.7
SMBL58	5/8	15.88	0.8
SMBL34	3/4	19.05	1.0



Stainless Steel Buckle

LX type

Modle	For band width		Thickness
	Inch	mm	mm
SMBLX14	1/4	6.35	0.6
SMBLX38	3/8	9.53	0.7
SMBLX12	1/2	12.70	0.7
SMBLX58	5/8	15.88	0.8
SMBLX34	3/4	19.05	1.0

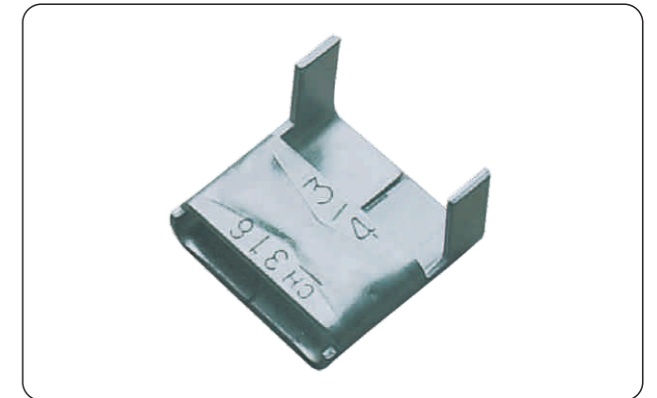

Screw type

Modle	For band width		Thickness
	Inch	mm	mm
SMBS14	1/4	6.35	1.5
SMBS38	3/8	9.53	1.8
SMBS12	1/2	12.70	2.0
SMBS58	5/8	15.88	2.5
SMBS34	3/4	19.05	2.5



Application Tools



SMBT001

Band Clamp Tool

SMBT002

Ratchet Tension Tool

SMBT003

Heavy Duty Tool

SMBT004

Ratchet Tensioner

SMBT005

Bantam Tool

Modle	Description	Weight
SMBT001	Band Clamp Tool for use with bands up to 3/4 "(19.05mm) wide	2.0kg
SMBT002	Ratchet Tension Tool for use with bands up to 3/4 "(19.05mm) wide, and also for all coated bands.	kg1.8kg
SMBT003	Heavy duty tool	2.3kg
SMBT004	Another type of ratchet tensioner for use with bands up to 3/4 "(19.05mm) wide and also for all coated bands.	1.8kg
SMBT005	It can be used with one hand. For using with bands up to 3/4 "(19.05mm) wide	1.5kg

APDM630–Single phase switch for NH fuses up to 630A

General Description

The APDM630 fuse switch it is used either as an operation or protection device for LV lines. It is designed to be used with NH 1-2 or 3 size fuses offering a maximum of 630 Amps of line protection without blades. In case blades are used, the maximum switching load would be 800 Amps. It is manufactured in reinforced fiberglass polyamide and fulfills all the necessary requirements for outdoor installation and operation. In the APDM 160C model the connection is made with connectors suitable for aluminum and copper conductors with a section range between 16 and 95 mm² (5-4/0 AWG). The closure of the cap allows the switch to be closed with or without a fuse, preventing the risk of leaving tension parts exposed. It may also be provided with a light emission diode (LED).

Features included

The switch fuse 160 APR has the following features included:

- indicator light fuse operation
- installed fuse indicator
- Sealable Safety
- inserts for mounting bipolar, tripolar, tetrapolar etc..
- eyelets suitable for proper and safe opening and closing operation,
- assembly and disassembly of the cover

Technical characteristics

(IEC60947)

Voltage	500 V
Insulation level	1000 V
Frequency	50/60 Hz
Operational current with fuses	630 A
with blades	800 A
Installation category	AC 22B
Short time current (1s)	12 KA
Dinamic current (crest)	50 KA
Interruption capacity	100 KA
Weigth	1.8 kg
Protection degree	IP 24

Optionals:

APDM- ① ② -630 ③ ④ ⑤ ⑥ ⑦ ⑧ ⑨ ⑩

- ① 2-bipolar mounting 3-tripolar mounting 4-tetrapolar mounting
- ② 2-bipolar operation 3-tripolar operation 4-tetrapolar operation
- ③ C-connectors
- ④ Y-simple-double D-double-double
- ⑤ R-pole vault screw maneuver L-extreme cold maneuver
- ⑥ H-connection seal
- ⑦ P-protector cover
- ⑧ K-arc chamber
- ⑨ X-Stainless steel bolts
- ⑩ N-unipolar wood support included S-unipolar cement support included

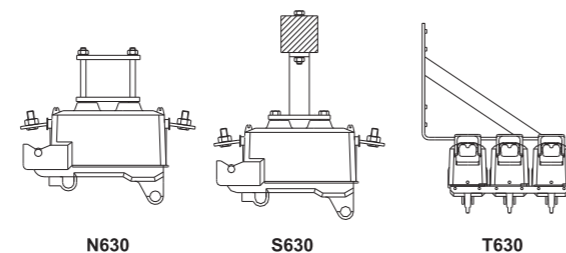
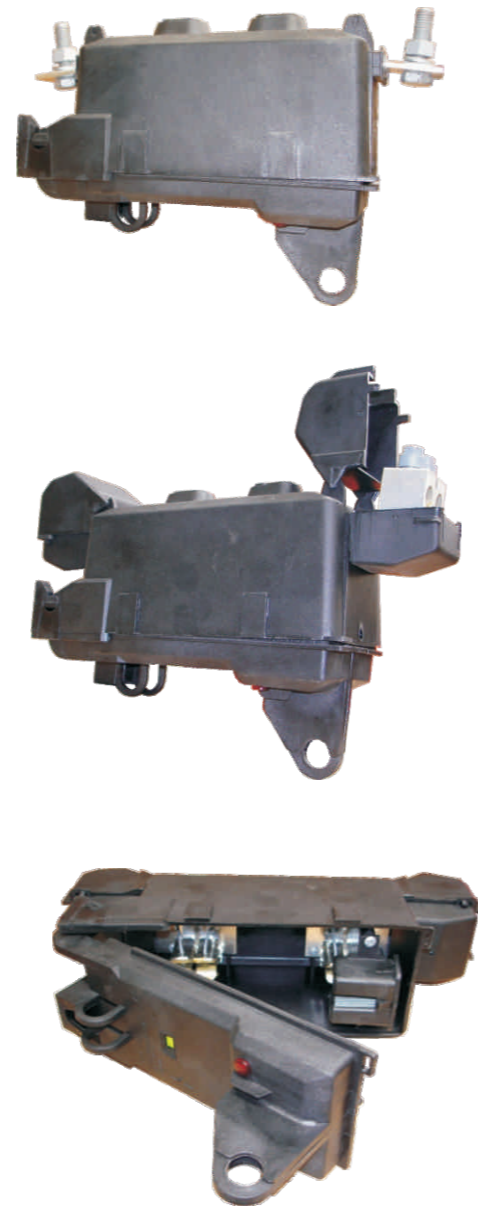

N630

S630

T630

APDM630–3–Four phase switch for NH fuses up to 630A, with three phase operation

General Description

This model is suitable for switching and protecting LV overhead lines, and/or to include a protection when doing a connection to low voltage underground systems. The design of this equipment allows the opening and closing of the three phases simultaneously and independently from the neutral, which is clearly identified to prevent its disconnection in rigidly landed systems. If required, it can be easily transformed in a single phase operation switch as the standard model APDM 400. It can be connected with terminals lugs (APDM630-3) or directly with its connectors (APDM400-3C).

Each phase and the neutral have an indicator which show if the fuse or the blade are installed. The closure of the cap allows the switch to be closed with or without the fuse preventing the risk of leaving live parts exposed.

It can also be provided with a led to show the fusion of the fuses.

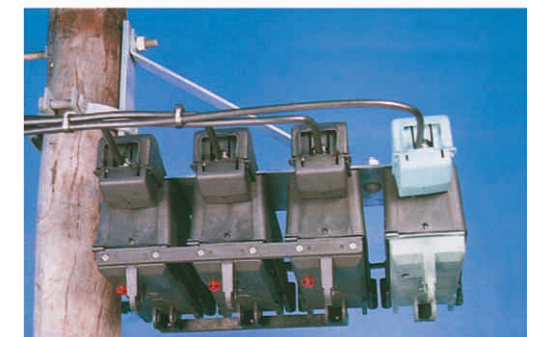
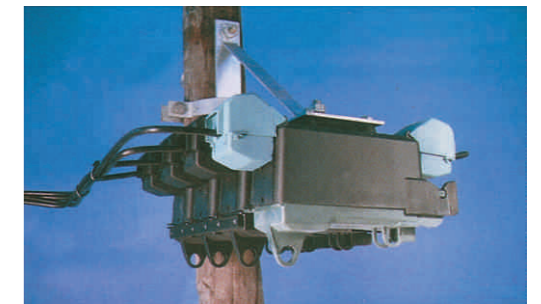

Technical Characteristics

Voltage	500V
Insulation level	1000V
Frequency	50/60Hz
Operational current with fuses	400A
Operational current with blades	600A
Installation category	AC22
Short lasting Current(1s)	8KA
Dynamic current(crest)	50KA
Interruption capacity	100KA
Operations behavior without load(oper)	800
Operations behavior(operation) (400 A Cos fi 0,65)	200
Weight	1.8kg
Protection range	IP 23



APDM160



APDM630

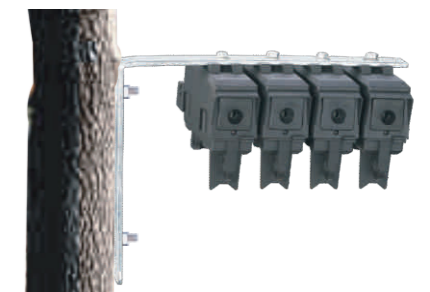

APDM400T switch for NH fuses up to 400A
General Description

This model is suitable for switching and protecting LV overhead lines, and/or to include a protection when doing a connection to low voltage underground systems. The design of this equipment allows the opening and closing of the three phases simultaneously and independently from the neutral, which is clearly identified to prevent its disconnection in rigidly landed systems. If required, it can be easily transformed in a single phase operation switch as the standard model APDM 400T. It can be connected with terminals lugs (APDM400T-3) or directly with its connectors (APDM400T-3C).

Each phase and the neutral have an indicator which show if the fuse or the blade are installed. The closure of the cap allows the switch to be closed with or without the fuse preventing the risk of leaving live parts exposed.

It can also be provided with a led to show the fusion of the fuses.

Technical Characteristics

Voltage	500V
Insulation level	1000V
Frequency	50/60Hz
Operational current with fuses	400A
Operational current with blades	400A
Installation category	AC22
Rated making and breaking capacity	1200A
Dynamic current(crest)	50KA
Rated conditional short-circuit current(rms)	80KA
Rated impulse withstand voltage(Uimp)	12KV
Operations behavior without load(oper)	800
Operations behavior(operation) (400 A Cos fi 0,65)	200
Weight	4kg
Protection range	IP 24

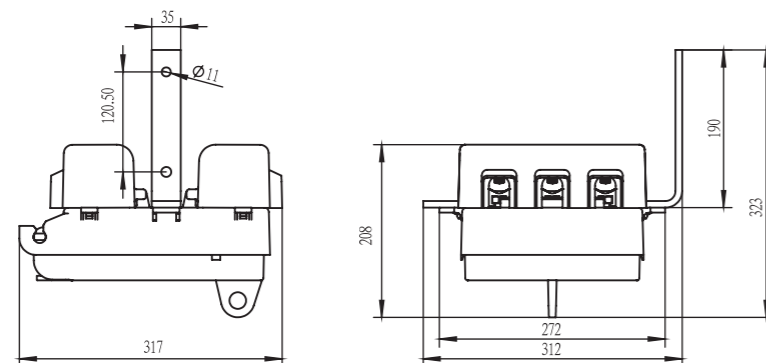
**Overhead Distribution
Fuse Service Equipment**

- Designed for IP43 rating and performance compliance with BS7656: 1993

Standart model: SMF-1

Note: Fuselink not included

This version can be pole, cross arm or wall mounted, its compact size allowing optimised arrangements resulting in less obtrusive installations.

Mechanical terminals with shear head bolts replace the studs usually associated with this type of cutout, eliminating the need for additional connecting lugs and specialised tools to ensure a simple, safe and effective joint.

The terminals will accept solid or stranded aluminium and solid copper conductors in the range 70 to 300mm². An adaptor is available for 25/35mm² copper or aluminium conductors.

The fuse carrier accepts 'J' type fuselinks to BS88 rated up to 400A.

With the PVC cable sealing grommets in place, the cutout is IP43 rated and has been designed to fully comply with the performance requirements specified in BS7656: 1993 for LV pole mounting fuses.

The enclosure is moulded in our own high performance, glass reinforced polyester, renowned and proven worldwide.

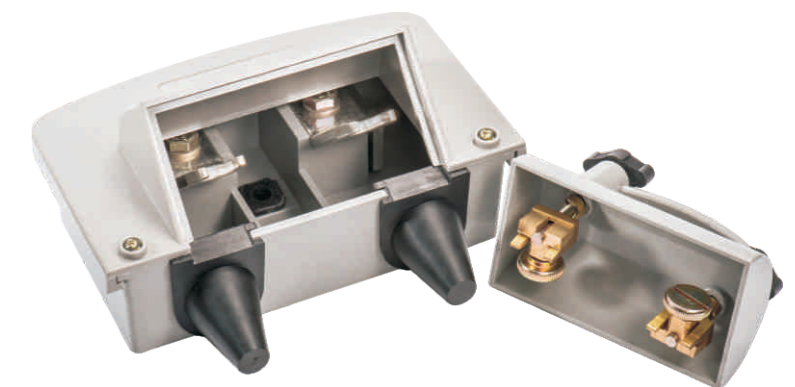

- Compact design for optimised mounting arrangements.
- Mechanical terminals require no additional lugs.
- Shear bolts-needs no special tools.
- Accepts aluminium and copper conductors between 70 and 300mm²

Fuselinks

This fused Cutout is designed to accommodate standard wedge "J" type fuselinks to BS 88 with 82 mm fixing centres.

Standard fuselink ratings range from 20 to 400A

Overhead Distribution

Fuse Service Equipment

Pole Mounted Cutouts

Rated at 400A

Standart model: SMF-2

Our industry standard unit is a very popular model.

Designed with ease of use and simplicity in mind, this pole mountable fused cutout is the ideal method of providing rural dwellings with a safe protected and reliable Low Voltage power supply.

Manufactured from our own track-resistant grade of Glass Reinforced Polyester, this fused Cutout is unobtrusive in appearance, but robust for outdoor applications.

Each fused Cutout includes M12 captive studs with nuts and washers for the reception of cable sockets (lugs) up to 300mm (compression type only) with copper or aluminium conductors.

For ease of mounting to either a wall or a wooden pole, the fused cutout is supplied with an M12 coach screw.

- Robust and tough design using our own formulation of DMC.
- Slide fit front cover for ease of jointing.
- “Easy fit” studs accept cable sockets (lugs) up to 300mm
- Designed to accept standard “J” type fuselinks
- Fully compliant with the requirements of BS 7656:1993
- Fully meeting the design criteria of IP43

Note: Fuselink not included



Fuselinks

This fused Cutout is designed to accommodate standard wedge “J” type fuselinks to BS 88 with 82 mm fixing centres.

Standard fuselink ratings range from 20 to 400A

Product Selection Chart



The SMF-3, Industry-Standard design, 400A rated fused Cut-out is one of our best selling products.

Designed with ease of use and simplicity in mind, this pole mountable fused Cut-out is the ideal method of providing rural dwellings with a safe, protected and reliable Low Voltage power supply.

Manufactured from our own track resistant grade of Glass Re-inforced Polyester, this fused Cut-out is unobtrusive in appearance and vandal resistant, when compared to many of the more traditional materials such as porcelain.

Each fused Cut-out has fuse contacts and cable terminal plates which are manufactured from copper and bright tinned. These plates incorporate M12 captive studs with nuts and washers for the reception of cable sockets (lugs) up to 300mm² (*compression type only at 300mm²) with copper or aluminium conductors.

For ease of mounting to either a wall or a wooden pole, the fused Cut-out is supplied with an M12 coach screw.

For cross-arm type mounting the Fused Cut-out can be supplied with an M12 nut, bolt and washer.

Technical Data

Modle	Fixing Arrangement
54611-18	400A Fused Cut-out for pole or wall mounting c/w M12 coach screw
54611-06	400A Fused Cut-out for cross-arm mounting c/w M12 bolt, nut and washer
58424-03	Spare fuse Carrier

Note:

Stepped washers recommended if lug palm has hole 16mm or greater.

Fuselinks

This fused Cut-out is designed to accommodate standard wedge type fuselinks to BS88 Part 5: 1988. Tested and approved for category of duty 415AC80.

Fixing centre requirement is 82mm.

Standard fuselink ratings range from 20 to 400A.

Cut Out Protection

Fuse Base
 Rated voltage:415V
 Standard:IEC60269-3 BS1361

Item	In(A)	Order No.	Price	Order No.	Price	Packing		
	CUT OUT 1P	Bakelite		Risen				
	22mm	30A	5901 000		5901 100	2/36		
	22mm	60/80A	5901 001		5901 101			
30mm	100A	5901 002		5901 102				
	CUT OUT 1P+N	Bakelite		Risen				
	22mm	30A	5902 000		5902 100	1/36		
	22mm	60/80A	5902 001		5902 101			
30mm	100A	5902 002		5902 102				
	CUT OUT Fuse of Plastic		Back wiring		Front wiring			
	1 Pole for Balck Color		In (A)	Order No.	price	Order No.	price	Packing
	22mm	Type IIa	60/80/100A	5901 221		5901 221		1/50
	30mm	Type IIb	100A	5901 301		5901 301		
	1 Pole for Fransparent		In (A)	Order No.	price	Order No.	price	Packing
	22mm	Type IIa	60/80/100A	5901 223		5901 224		1/50
	30mm	Type IIb	100A	5901 303		5901 304		

Cut Out Protection

Fuse Link
 Rated voltage:415V;Rated Breaking Capacity:80kA
 Standard:IEC60269-3 BS1361

Item	In(A)	Order No.	Price	Packing
Fuse-link for CUT OUT				
	5 (6)	5910 005		10/250
	10	5910 010		
	15	5910 015		
	20	5910 020		
	30 (32)	5910 030		
	60	5910 060		
	80	5910 080		
	100	5910 100		
	60	5911 060		10/200
	80	5911 080		
	100	5911 100		

Dimensions

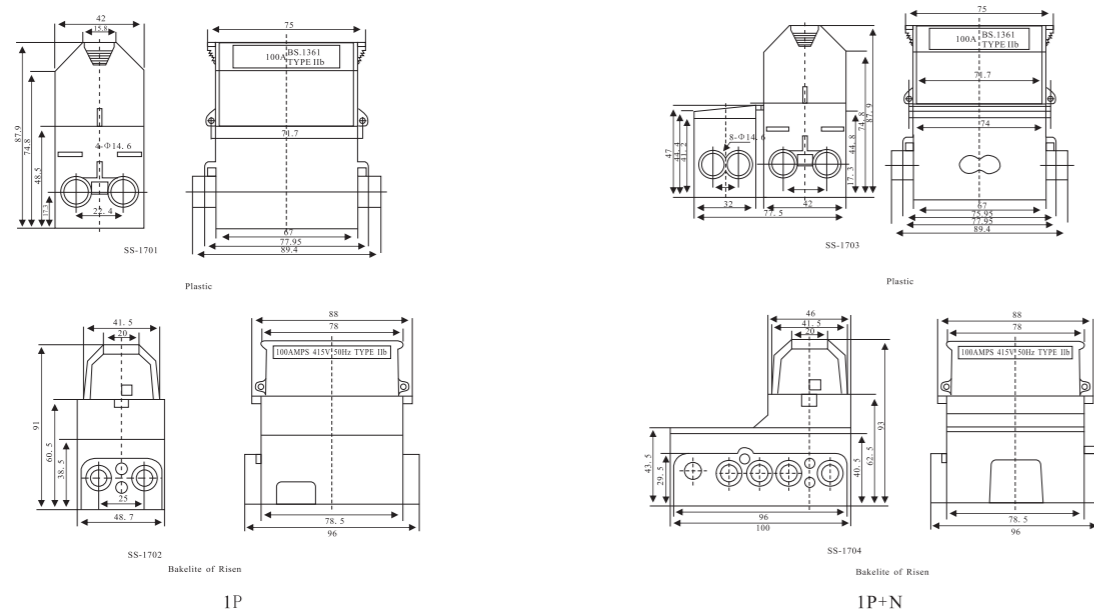

Junction box sealed connections in low voltage aerial network connections cdbS-tsc



CHARACTERISTIC TECHNIC:

Material:	Polycarbonate with anti-uv
Dimension:	285mmX295mmX65mm
Bypass bar:	copper alloy;
	322 Mm2 section for phases and 144M2 for neutral;
	6 connection points for phases and 11 for the neutral;
	busbar coating:epoxy resin (dielectric resistance 180kv / cm)
terminal protection:	cable lugs with rubber plugs screw holes: strips of rubber plugs
hinges:	2 hinges of the same material of the caia
lock:	1 Allen Head Bolt
operating temperature:	<= 90°C
fastening to the pole or vain:	2 metal strap pins (post), 2 holes for headband (for span)
connection torque:	2.6 N-m 8 23 IN-LG)
NUMBER OF RUSHES:	9 SINGLE PHASE + 1 APV IN 370 / 220V SYSTEM
CABLE SECTION:	POWER SUPPLY CABLE: UP TO 16mm2
	branch cable up to 16mm2
nominal load:	60KW
maximum load:	75KW

APPLICATION:

Used as a single-phase and / or three-phase connection in low voltage in the air network, for areas of high corrosion and high industrial contamination.

Low Voltage H.R.C Fuse

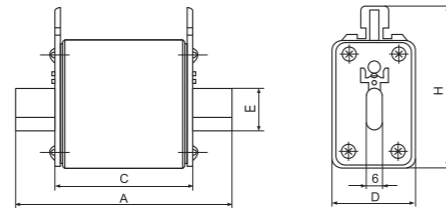

Basic Data

Model	Domestic and overseas similar products		Rated voltage (V)	Rated current (A)	Over all dimension(mm)				
	gG	aR			A	C	D	E	H
NH00C	NH00C	RS30C	500/690	4-100	78.5	49.5	21	15	52.5
NH00	NH00	RS31	500/690	10-160	78	50.5	30	15	60
NH0	NH0		500/690	6-160	125	67	30	15	60

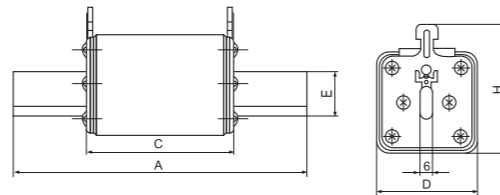

Basic Data

Model	Domestic and overseas similar products		Rated voltage (V)	Rated current (A)	Over all dimension(mm)				
	gG	aR			A	C	D	E	H
NH1	NH1	RS32	500/690	32-250	135	68	46	20	58.5
NH2	NH2	RS33	500/690	80-400	150	68	58	25	68.5
NH3	NH3	RS34	500/690	160-630	150	68	70	32	82

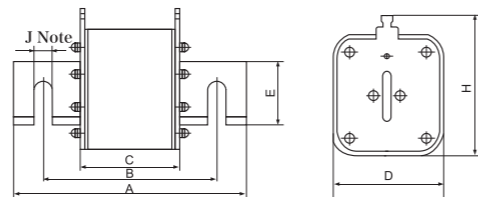

Basic Data

Model	Domestic and overseas similar products		Rated voltage (V)	Rated current (A)	Over all dimension(mm)					
	gG	aR			A	B	C	D	H	J
NH4	NH4	RS39	500/690	500-1250	200	150	90	97	113	16.5

Note: It is allowable to change the double-transverse type wiring hole one-transverse one-straight or double-straight type structure

Low Voltage H.R.C Fuse

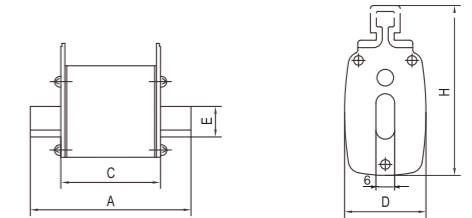

Basic Data

Model	Domestic and overseas similar products		Rated voltage (V)	Rated current (A)	Over all dimension(mm)				
	gG	aR			A	C	D	E	H
RO30A	NH00C		500/690	4-125	78	49	21	15	48
RT16-000	NT00CNH00C	RS30C	500/690	4-125	78	49	21	15	52
RT16-00	NT00NH00RT20-003NA	RS31	500/690	4-160	78	49	29	15	56
RT16-0	NT0NH0		500/690	4-160	125	68	29	15	56

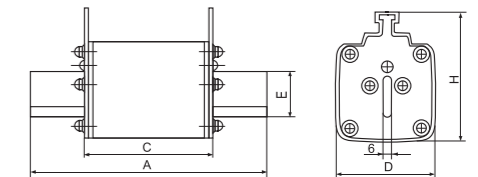

Basic Data

Model	Domestic and overseas similar products		Rated voltage (V)	Rated current (A)	Over all dimension(mm)				
	gG	aR			A	C	D	E	H
RT16-1	NT1NH1	RS32	500/690	32-250	135	68	48	20	60
RT16-2	NT2NH2	RS33	500/690	80-400	150	68	58	25	72
RT16-3	NT3NH3	RS34	500/690	160-630	150	68	68	32	84

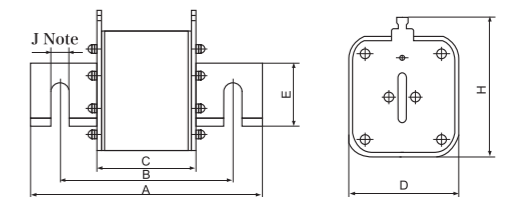

Basic Data

Model	Domestic and overseas similar products		Rated voltage (V)	Rated current (A)	Over all dimension(mm)					
	gG	aR			A	B	C	D	H	J
RT16-4	NT4RT17	RS39	500/690	500-1250	200	150	90	97	113	16.5

Note: It is allowable to change the double-transverse type wiring hole one-transverse one-straight or double-straight type structure

Low Voltage H.R.C Fuse

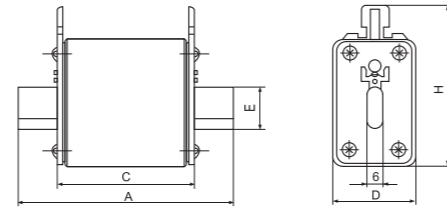

Basic Data

Model	Domesticand overseas similar products	Rated voltage (V)	Rated current (A)	Over all dimension(mm)				
				A	C	D	E	H
NH000S	NH000S	500/690	4-100	78.5	49.5	21	15	52.5
NH00S	NH00S	500/690	10-160	78	50.5	30	15	60
NH0S	NH0S	500/690	6-160	125	67	30	15	60

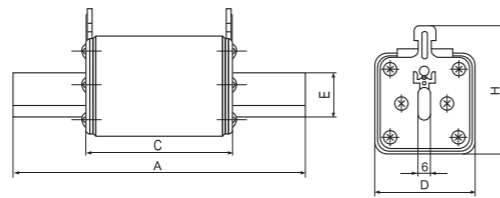

Basic Data

Model	Domesticand overseas similar products	Rated voltage (V)	Rated current (A)	Over all dimension(mm)				
				A	C	D	E	H
NH1S	NH1S	500/690	32-250	135	68	46	20	58
NH2S	NH2S	500/690	80-400	150	68	58	25	68
NH3S	NH3S	500/690	160-630	150	68	80	32	82

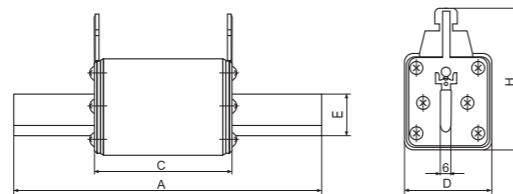

Basic Data

Model	Domesticand overseas similar products	Rated voltage (V)	Rated current (A)	Over all dimension(mm)				
				A	C	E	D	H
NH1C	NH1Csmallcapacity	500/690	16-160	136	68	15	30	67
NH2C	NH2Csmallcapacity	500/690	35-250	150	67	20	46	67
NH3C	NH3Csmallcapacity	500/690	200-400	151	67	25	58.5	81.5

Low Voltage H.R.C Fuse

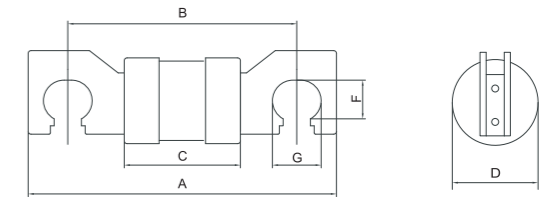

Basic Data

Model	Domesticand overseas similar products	Rated voltage (V)	Rated current (A)	Over all dimension(mm)					
				A	B	C	D	F	G
76JPU	RG8M	415/550	20~200	100	76	45	40	14	13
82JPU	RG8M	415/550	200~400	111	82	45	40	14	17
92JPU	RG8M	415/550	400~630	131	92	45	56	17	20

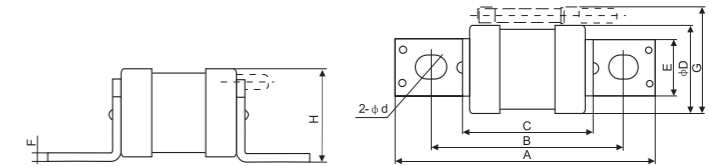

Basic Data

Model	Domesticand overseas similar products	Rated voltage (V)	Rated current (A)	Over all dimension(mm)							
				A	B	C	ΦD	E	F	H	2-Φd
RG11	RGS11	250/380	32	56	42	27.5	16.5	12.5	2	17.5	6.5x9
RG4(Z)	RGS4(Z)	660/1000	63	77	62	49.5	16.5	12.5	2	18	6.5x9
RG44(Z)	RGS44(Z)	500	100	94	72	49	32.5	25	2	21.5	11x14
RG7(Z)	RGS7(Z)	500	100	113	94	68	34	19	2	35	9x11.5

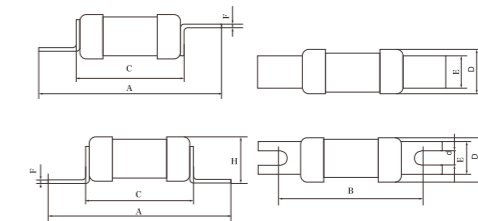

Basic Data

Model	Rated voltage (V)	Rated current (A)	Over all dimension(mm)					
			A	B	ΦD	E	F	H
F1 NS	550V80KA	2-32	59		13.5	11	0.8	
F1 NSS			64		16	14.5	1	
A1 NIT	550V80KA	2-32	55	44.5	13.5	11	0.8	14.5
A2 TIA	550V80KA	2-63	86	73	22	13	.2	24
A2 TIS	550V80KA	2-63	86	73	22	13	1.2	24
A3 TCP	550V80KA	40-100	110	94	27	19	2.0	28
A4 TFP	550V80KA	125-200	117	94	35	20	2.0	38
B1	550V80KA	2-63		111				
B1 TBC	550V80KA	2-63	137	111	22	15		
B1 TC	550V80KA	80-100						
B2 TF	550V80KA	125-200	137	111	38	18		
B3 TKF	550V80KA	-315	137	111	49	26		
B4 TKM	550V80KA	-400	137	111	56	26		

Aluminium Copper and Bimetallic type

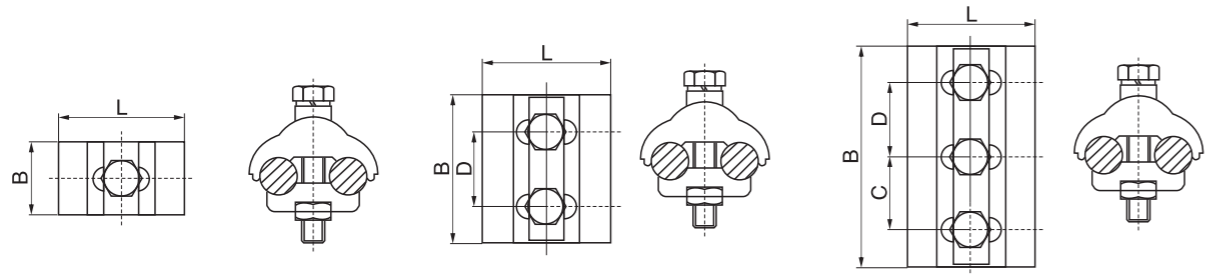

Technical Data

Modle	Conductor Cross-section(mm ²)	Bolts
CAPG-A1	Cu 6-50 Al 16-70	1×M8×40
CAPG-A2	Cu 10-95 Al 25-150	1×M8×45
CAPG-B1	Cu 6-50 Al 16-70	2×M8×45
CAPG-B2	Cu 10-95 Al 25-150	2×M8×50
CAPG-B3	Cu 25-185 Al 35-200	2×M10×60
CAPG-C1	Cu 6-50 Al 16-70	3×M8×45
CAPG-C2	Cu 10-95 Al 25-150	3×M8×50
CAPG-C3	Cu 25-185 Al 35-240	3×M10×60
CAPG-C4	Cu 35-240 Al 35-300	3×M10×70

Parallel groove connectors AL/AL

Material

High strength aluminum alloy by forging. Surface treatment: Bright.

Product property

ALPG is used for connecting or branching AAC, AAAC or ACSR overhead conductors. Forging creates a high strength clamp. Slotted holes allow adjustment for varying conductors on each side. Its type test is in accordance with IEC61238-1.

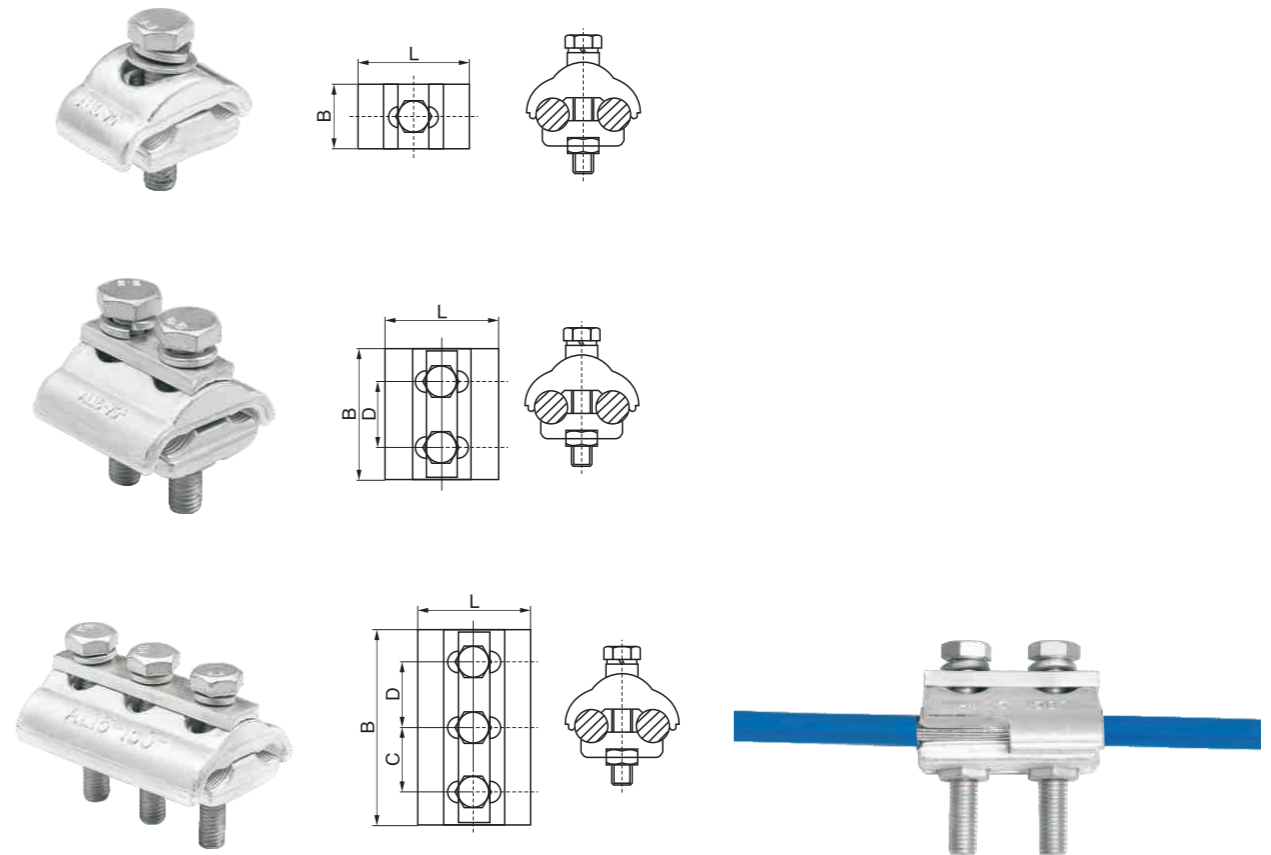

Technical Data

Modle	Conductor Cross-section(mm ²)	Bolts
APG-A1	Al 16-70	1×M8×40
APG-A2	Al 16-150	1×M8×45
APG-B1	Al 16-35	2×M6×35
APG-B2	Al 16-70	2×M8×45
APG-B3	Al 16-150	2×M8×50
APG-B4	Al 25-185	2×M10×60
APG-C1	Al 16-70	3×M8×45
APG-C2	Al 16-150	3×M8×50
APG-C3	Al 25-240	3×M10×60
APG-C4	Al 35-300	3×M10×70

Parallel groove connectors CU/CU

Parallel Groove Clamps Copper Extruded type

The clamp was designed to connect two parallel bare conductors. Conductors can be copper stranded or rods. Material is forged copper for copper to copper connection throughout the conductor range. The clamps have serrated transverse grooves for maximum conductor contact, use copper bolts and utilise Belleville washers to prevent thermal ratcheting under cyclic loads.

The clamps are coated with an oxide inhibitor. And stainless bolts and nuts with washers was on requirement.

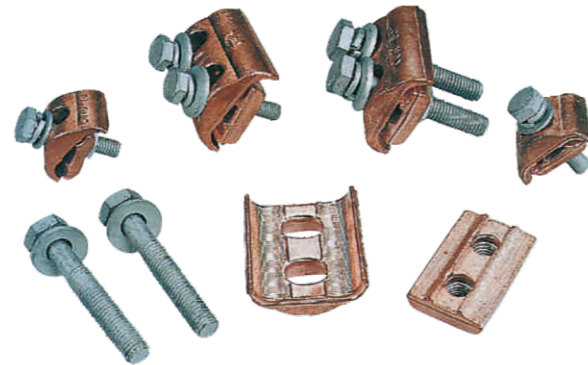

For tap-off connections of copper-conductors acc. to DIN 48201

Material

Body: Copper alloy

Bolts: steel or stainless steel

Nuts: DIN 934, steel

Surface: uncoated

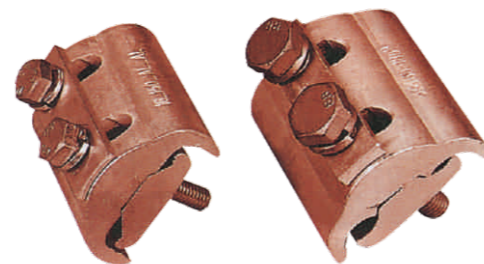
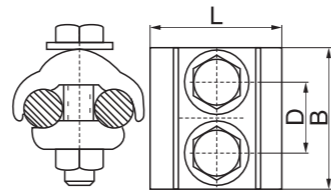

Modle	Bolt Torque	Conductor Range mm ²	Dimensions mm O.D	No./Size of Bolts
CU6-70-2	20Nm	6 to 70	2.7 to 10.5	2×M8
CU16-95-2	20Nm	16 to 95	5.1 to 12.5	2×M8
CU16-150-2	30Nm	16 to 150	5.1 to 15.7	2×M10
CU150-240-2	40Nm	150 to 240	15.7 to 20.3	2×M12
CU300-400-3	40Nm	300 to 400	22.6 to 26.7	3×M12

Insulating covers

SM1 and SM2, SM3 are used as a connector covers.

The covers are used with Al/Al and Al/Cu connectors as insulation and protection against corrosion caused by various climatic conditions. The cover has to be installed so that the drain hole for ambient water is downwards.

The cover is made of UV-radiation and weather resistant thermoplastic. The insulating covers was suitable for type, it have two size, the small insulating cover was use for conductor size till 120mm², and the big cover was use for conductor size till 240mm². The SI3 type covers has to be installed with the holes in the clamp body, we have two size for 120mm²(max) and for 240mm²(max).

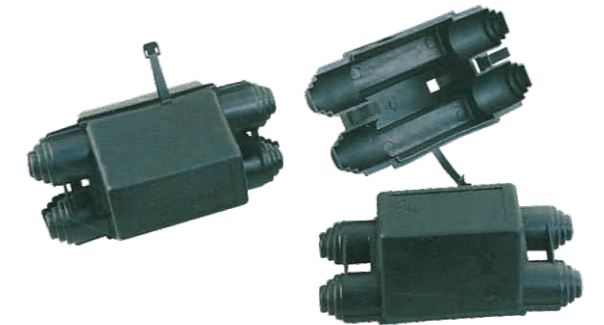

Modle	Conductor size mm ² (Max)	Suitable for clamp
SM1-1	16-150	CAPG,APG,ALPG,CUPG,PGS,PGT,SM,JBL,JBTL,JBT
SM1-2	35-240	CAPG,APG,ALPG,CUPG,PGS,PGT,SM,JBL,JBTL,JBT
SM2-1	16-120	CAPG,APG,ALPG,CUPG,PGS,PGT,SM,JBL,JBTL,JBT
SM2-2	35-240	CAPG,APG,ALPG,CUPG,PGS,PGT,SM,JBL,JBTL,JBT
SM3-1	16-150	CAPG,APG,CUPG
SM3-2	35-200	CAPG,APG,CUPG

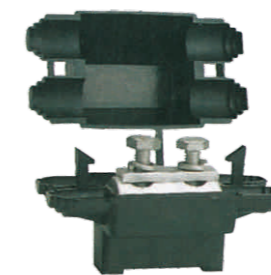

SM1



SM2

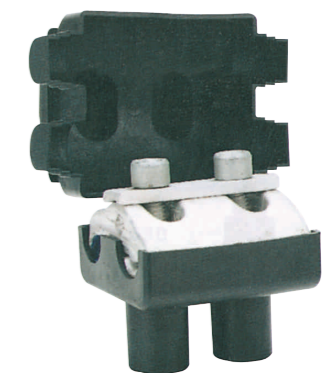

SM3

Dead end clamp



JBH

Material: High strength aluminium alloy
 Product property: JBH is used for the anchoring of the uninsulated messengers by means of hooks to either a pole or a wall. The clamp is a unit without loose parts.

Modle	Cross-section (mm ²)	Failure Load (kN)
JBH-1	16	4.0
JBH-2	25	6.6
JBH-3	35	9.3
JBH-4	50	13.2
JBH-5	70	15.0

Bolted type strain clamp



NLL

Material: High strength aluminium alloy by casting
 Product property: NLL is suitable for aerial line up to 35kV, fixing stranded aluminum wire, steel-cored aluminum strand on the strain pole, or aerial insulated aluminum conductor. Smooth surface makes a long service life. Easy installation. No waste of electric energy.

Modle	Conductor Diameter (mm)	Specification		U-bolted	Failure Load (kN)
		1kV (mm ²)	10kV (mm ²)		
NLL-0	5.0-10.0	---	---	2×M12	40
NLL-1	5.0-10.0	25-70	10-25	2×M12	40
NLL-2	10.1-14.0	50-120	25-50	2×M12	40
NLL-3	14.1-18.0	120-240	70-120	3×M14	70
NLL-4	18.1-23.0	185-300	150-240	3×M14	90

FTY Preformed armour



Chamfered End



Ball End



EHV End

Modle	Conductor		Dimensions(mm)			Nos of wires	Weight(kg)
	Type	Outer dia(mm)	d	D	L		
FTY-95/15	LGJ-95/15	13.61	3.6	11.4	1400	13	0.53
FTY-95/20	LGJ-95/20	13.87	3.6	11.4	1400	13	0.54
FTY-120/20	LGJ-120/20	15.07	3.6	12.5	1400	14	0.57
FTY-120/25	LGJ-120/25	15.74	3.6	13.0	1400	14	0.58
FTY-150/20	LGJ-150/20	16.67	3.6	14.7	1500	16	0.65
FTY-150/25	LGJ-150/25	17.10	3.6	14.2	1500	16	0.64
FTY-150/35	LGJ-150/35	17.50	3.6	14.5	1500	16	0.66
FTY-185/25	LGJ-185/25	18.90	4.6	15.7	1800	14	1.25
FTY-185/30	LGJ-185/30	18.88	4.6	15.7	1800	14	1.26
FTY-185/45	LGJ-185/45	19.60	4.6	16.3	1800	14	1.26
FTY-240/30	LGJ-240/30	21.60	4.6	17.9	1900	16	1.44
FTY-240/40	LGJ-240/40	21.66	4.6	17.9	1900	16	1.44
FTY-240/55	LGJ-240/55	22.40	4.6	18.6	1900	16	1.50
FTY-300/20	LGJ-300/20	23.43	6.3	19.4	2000	13	2.30
FTY-300/25	LGJ-300/25	23.76	6.3	19.7	2000	13	2.33
FTY-300/40	LGJ-300/40	23.94	6.3	19.9	2000	13	2.34
FTY-300/50	LGJ-300/50	24.26	6.3	20.1	2000	13	2.34
FTY-400/25	LGJ-400/25	26.64	6.3	22.1	2200	14	2.80
FTY-400/35	LGJ-400/35	26.82	6.3	22.3	2200	14	2.80
FTY-400/50	LGJ-400/50	27.63	6.3	23.0	2200	14	2.80
FTY-400/65	LGJ-400/65	28.00	6.3	23.2	2200	14	2.83
FTY-500/35	LGJ-500/35	30.00	6.3	24.9	2500	16	3.48
FTY-500/45	LGJ-500/45	30.00	6.3	24.9	2500	16	3.48
FTY-500/65	LGJ-500/65	30.96	6.3	25.7	2500	16	3.50
FTY-630/45	LGJ-630/45	33.60	7.8	27.9	2500	15	5.32
FTY-630/55	LGJ-630/55	34.32	7.8	28.5	2500	15	5.40
FTY-630/80	LGJ-630/80	34.32	7.8	28.9	2500	15	5.40

Connector press type O

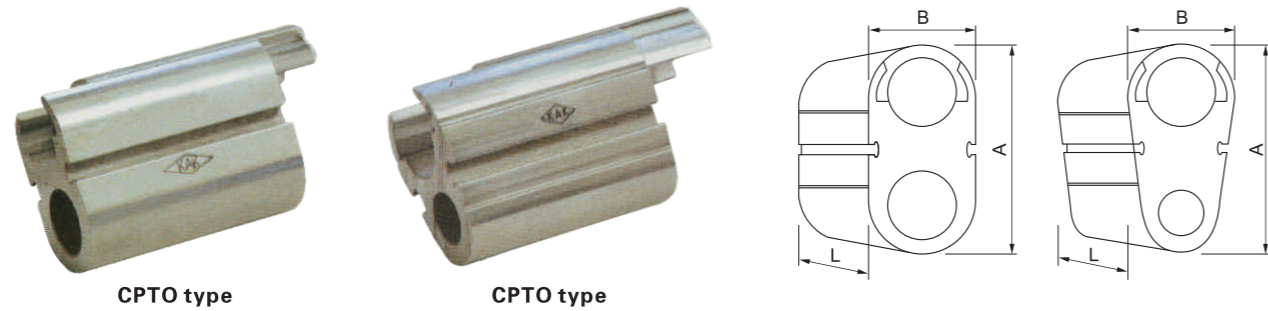

Specification for CPTO type

Modle	Hole1 mm ²	Hole2 mm ²	Dimensions(mm)		
			A	B	L
CPTO 10-16/10-16	10-16	10-16	18.8	10.5	35.3
CPTO 10-35/10-16	25-35	10-16	22.8	14.5	37.7
CPTO 10-35/16-35	25-35	25-35	26	14	38.6
CPTO 50-70/10-16	50-70	10-16	29.5	19.5	37
CPTO 50-70/16-35	50-70	25-35	28.4	20	38
CPTO 50-70/50-70	50-70	50-70	33.8	20	45.5
CPTO 70-150/50-70	70-150	50-70	44	23.6	60.3
CPTO 70-150/70-150	70-150	70-150	49	23.6	60.3
CPTO 150-240/70-150	150-240	70-150	54.8	30.3	65
CPTO 150-240/150-240	150-240	150-240	62.4	30.3	75.5

Connector press type H

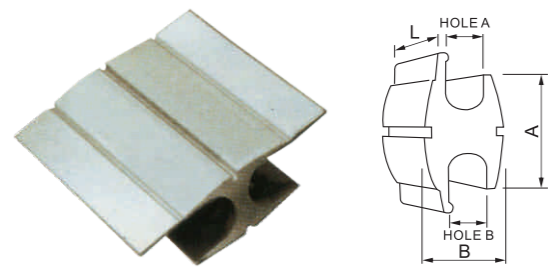

CPTH type

Specification for CPTH type

Modle	Hole1 mm ²	Hole2 mm ²	Dimensions(mm)		
			A	B	L
CPTH 35-35	16-35	16-35	17.5	23.8	38
CPTH 35-70	16-35	35-70	17.8	26	46
CPTH 70-70	35-70	35-70	20.6	30.5	47
CPTH 120-120	70-120	70-120	22.7	36.5	52
CPTH 70-150	35-150	70-150	23	34.5	70
CPTH 150-150	70-150	70-150	25.4	39.5	70
CPTH 70-240	35-70	120-240	28	42	90
CPTH 150-247	70-150	120-240	32	46	90
CPTH 240-240	120-240	120-240	32	52	90
CPTH 300-300	150-300	150-300	32	52	100

Connector press CPTG type

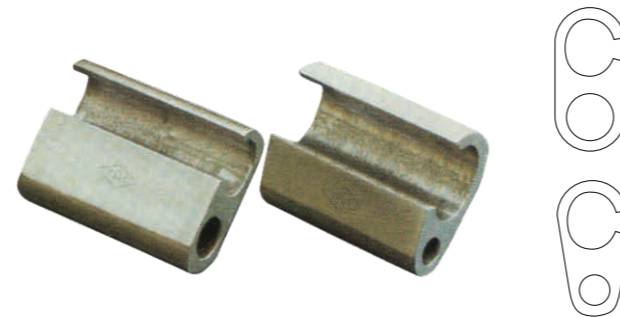

Specification for CPTG type

Modle	Hole1 mm ²	Hole2 mm ²	Dimensions(mm)		
			A	B	L
CPTG 10-16/10-16	16-35	16-35	17.5	23.8	38
CPTG 16-35/10-16	16-35	35-70	17.8	26	46
CPTG 16-35/16-35	35-70	35-70	20.6	30.5	47
CPTG 50-70/10-16	70-120	70-120	22.7	36.5	52
CPTG 50-70/16-35	35-150	70-150	23	34.5	70
CPTG 50-70/50-70	70-150	70-150	25.4	39.5	70
CPTG 70-150/50-70	35-70	120-240	28	42	90
CPTG 70-150/70-150	70-150	120-240	32	46	90
CPTG 150-240/70-150	120-240	120-240	32	52	90
CPTG 150-240/150-240	150-300	150-300	32	52	100

Anchor Clamp Class



SM-001 SM-002 SM-003 SM-004

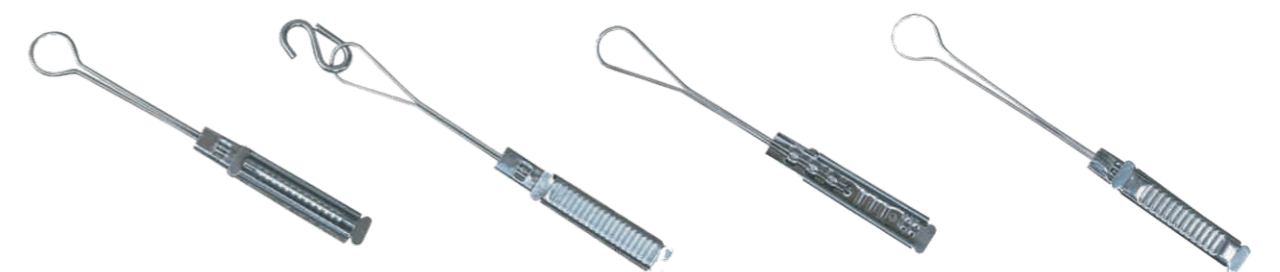

SM-005 SM-006 SM-007 SM-008



SM-009 SM-010 SM-011 SM-012



SM-013 SM-014 SM-015 SM-016

Anchor Clamp Class



SM-017 SM-018 SM-019 SM-020

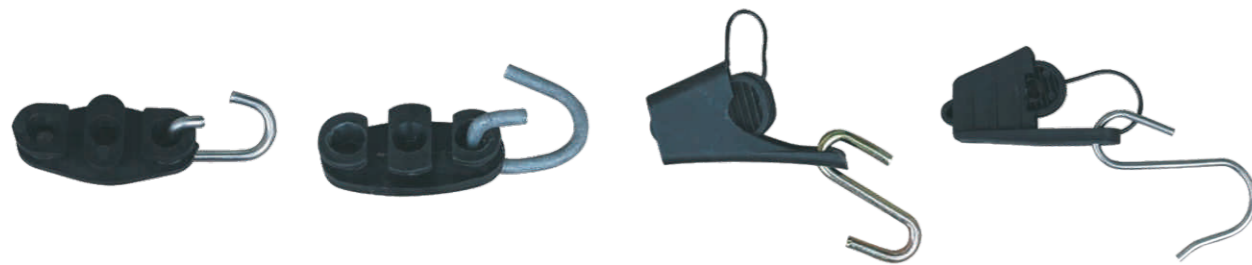

SM-021 SM-022 SM-023 SM-024

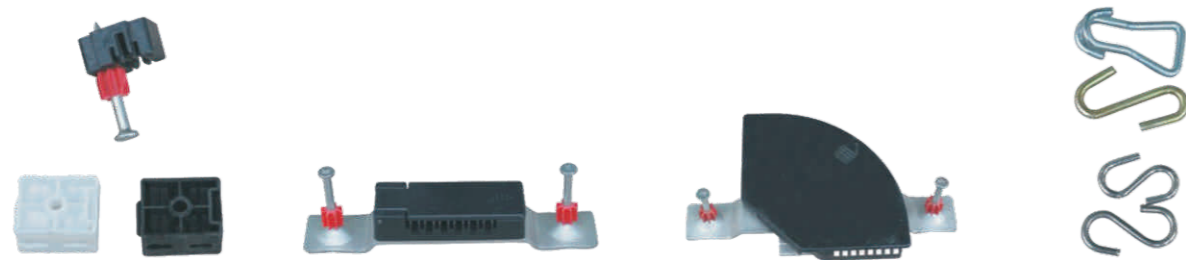

SM-025 SM-026 SM-027 SM-028



SM-029 SM-030 SM-031 SM-032

Anchor Clamp Class



SM-033 SM-034 SM-035 SM-036

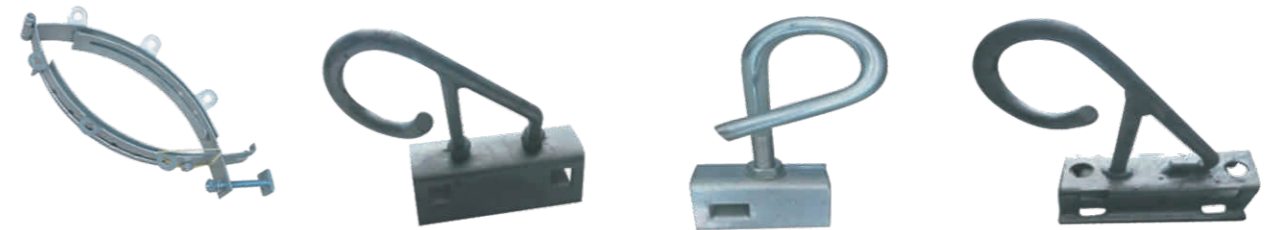

SM-037 SM-038 SM-039 SM-040

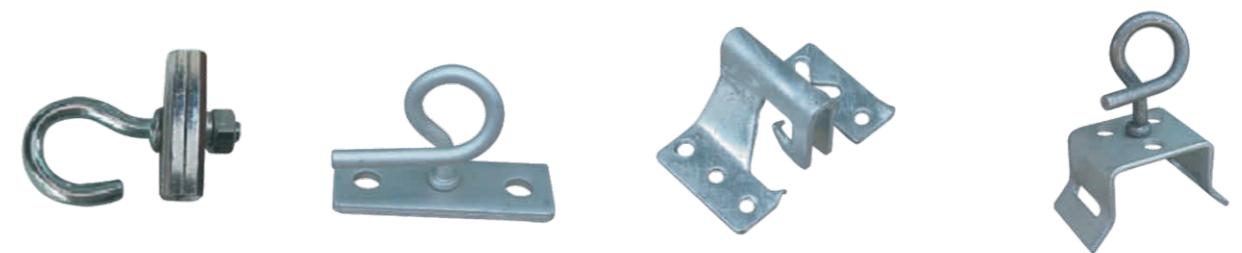

SM-041 SM-042 SM-043 SM-044

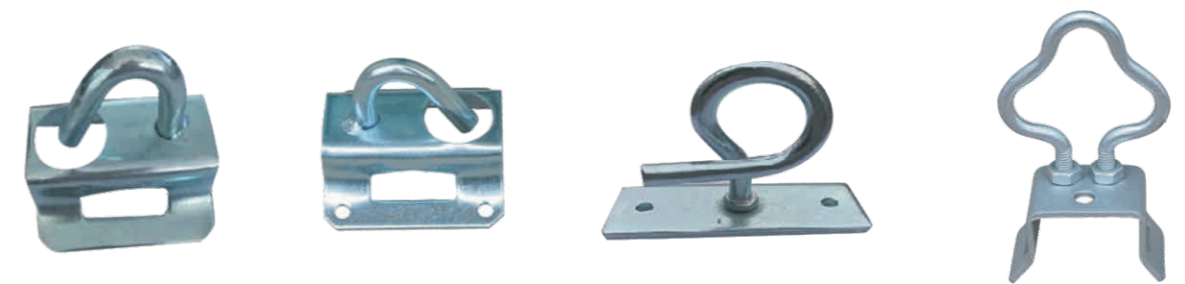

SM-045 SM-046 SM-047 SM-048

Anchor Clamp Class



SM-049



SM-050



SM-051



SM-052



SM-053



SM-054



SM-055



SM-056



SM-057



SM-058

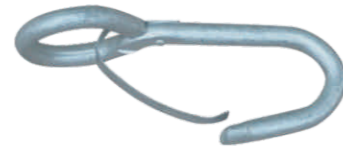

SM-059



SM-060



SM-061



SM-062



SM-063

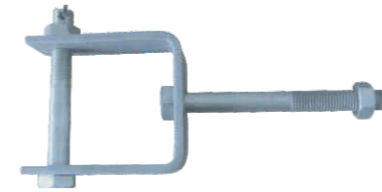

D type iron set



Spindile



Eye bolts



Socket



The iron hang plank



Flower orchid screw



Hook bolt



Eye bolts



Iron rod



Pigtail bolt



Pigtail bolt



Hook bolt



Wire rope thimble



Spindile



Square head machine bolt & nut



Pull wires accessories



The T type line clip



The line clip



Hook



U Bolts



Rigging

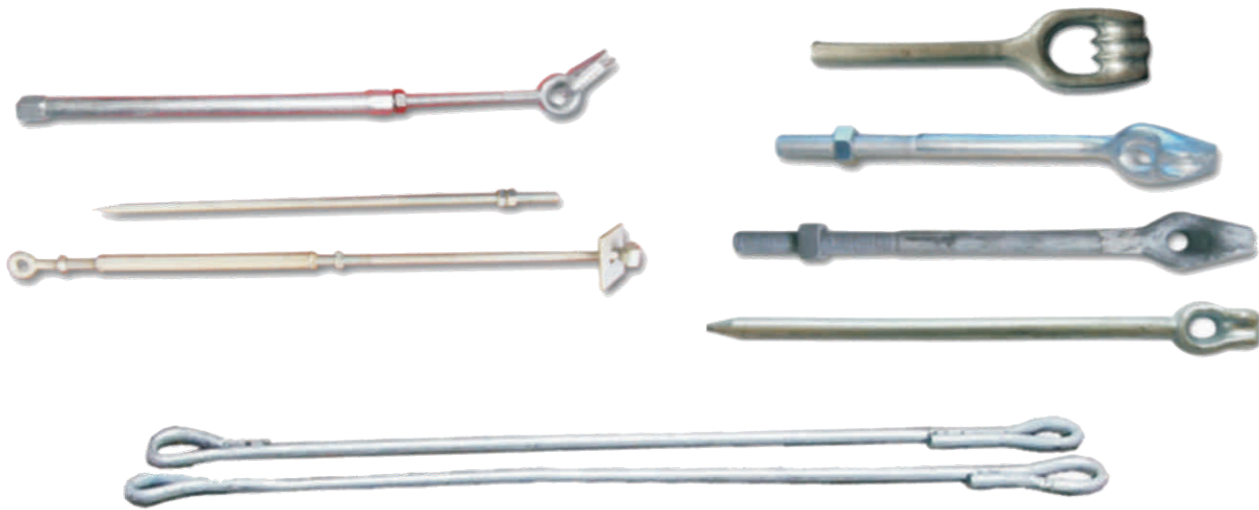

Stay Rod



Clevis

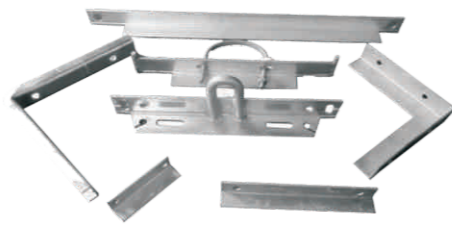

Cross Arm

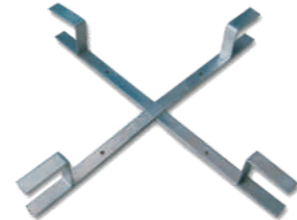

Earth Rod

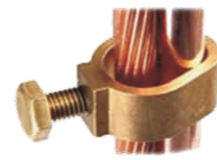

B

CABLE AND WIRE TERMINALS

Cable lug



JM(JGK)

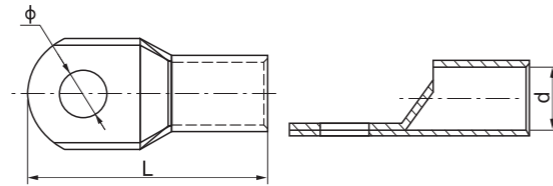

Material: E-Cu
 Surface treatment: Tin-plated
 Product Property: It is used to connect the copper conductor end.
 It has a viewing window to check the conductor location.

Modle	Dimensions(mm)		
	L	d	φ
JM(JGK) 1.5-4	18	1.9	4.2
JM(JGK) 1.5-5	18	1.9	5.2
JM(JGK) 1.5-6	18	1.9	6.5
JM(JGK) 2.5-4	19	2.8	4.3
JM(JGK) 2.5-5	20	2.8	5.2
JM(JGK) 2.5-6	20	2.6	6.5
JM(JGK) 4-4	19.5	3.2	4.3
JM(JGK) 4-5	20.5	3.2	5.2
JM(JGK) 4-6	22	3.2	6.5
JM(JGK) 6-5	22	3.7	5.2
JM(JGK) 6-6	23	3.7	6.5
JM(JGK) 6-8	24	3.7	8.4
JM(JGK) 6-10	24	3.7	10.3
JM(JGK) 10-6	24	4.5	6.5
JM(JGK) 10-8	25	4.5	8.4
JM(JGK) 10-10	26.5	4.5	10.3
JM(JGK) 16-6	27.5	5.7	6.5
JM(JGK) 16-8	29.5	5.7	8.4
JM(JGK) 16-10	30	5.7	10.5
JM(JGK) 25-6	32.5	7.2	6.5
JM(JGK) 25-8	33	7.2	8.4
JM(JGK) 25-10	34	7.2	10.5
JM(JGK) 25-12	37	7.2	13
JM(JGK) 35-6	36	8.5	6.5
JM(JGK) 35-8	37	8.5	8.5
JM(JGK) 35-10	38	8.5	10.5
JM(JGK) 35-12	38	8.5	13
JM(JGK) 50-6	41	9.8	6.5
JM(JGK) 50-8	42.5	9.8	8.5
JM(JGK) 50-10	44	9.8	10.5
JM(JGK) 50-12	44	9.8	13
JM(JGK) 50-14	44	9.8	14.7
JM(JGK) 70-8	48.5	11.5	8.5
JM(JGK) 70-10	50	11.5	10.5
JM(JGK) 70-12	50	11.5	13
JM(JGK) 95-8	57	13.7	8.5
JM(JGK) 95-10	57	13.7	10.5
JM(JGK) 95-12	57	13.7	13
JM(JGK) 95-14	57	13.7	15
JM(JGK) 95-16	57	13.7	17

Modle	Dimensions(mm)		
	L	d	φ
JM(JGK) 120-10	61.5	15	10.5
JM(JGK) 120-12	63	15	13
JM(JGK) 120-14	63	15	14.7
JM(JGK) 120-16	63.5	15	17
JM(JGK) 120-20	67.5	15	21
JM(JGK) 150-10	71	16.7	10.5
JM(JGK) 150-12	71	16.7	13
JM(JGK) 150-14	71	16.7	14.7
JM(JGK) 150-16	71	16.7	17
JM(JGK) 185-10	77	19.2	10.5
JM(JGK) 185-12	77	19.2	13
JM(JGK) 185-14	77.5	19.2	14.7
JM(JGK) 185-16	79	19.2	17
JM(JGK) 185-18	79	19.2	18.7
JM(JGK) 185-20	79	19.2	21
JM(JGK) 240-10	89.5	21	10.5
JM(JGK) 240-12	89.5	21	13
JM(JGK) 240-14	90	21	14.7
JM(JGK) 240-16	91	21	17
JM(JGK) 240-20	92	21	21
JM(JGK) 300-10	100	24	10.5
JM(JGK) 300-12	100	24	13
JM(JGK) 300-16	100	24	17
JM(JGK) 300-20	102	24	21
JM(JGK) 400-12	111	27	13
JM(JGK) 400-16	111	27	17
JM(JGK) 400-18	113	27	18.5
JM(JGK) 400-20	113	27	21
JM(JGK) 500-16	123	30	17
JM(JGK) 500-20	123	30	21
JM(JGK) 630-16	135	35	17
JM(JGK) 630-20	135	35	21
JM(JGK) 630-22	135	35	23
JM(JGK) 630-8/4	135	35	8.5
JM(JGK) 630-10/4	135	35	10.5
JM(JGK) 800-20	170	39	21
JM(JGK) 800-22	170	39	23
JM(JGK) 1000-20	200	44	21
JM(JGK) 1000-22	200	44	23

Cable lug



JM(JGY)

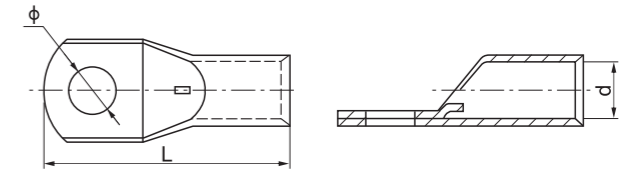

Material: E-Cu
 Surface treatment: Tin-plated
 Product Property: It is used to connect the copper conductor end.
 It has a viewing window to check the conductor location.

Modle	Dimensions(mm)		
	L	d	φ
JM(JGY) 6-5	25	3.7	5.2
JM(JGY) 6-6	25	3.7	6.5
JM(JGY) 6-8	25	3.7	8.4
JM(JGY) 10-5	26	4.5	5.3
JM(JGY) 10-6	26	4.5	6.5
JM(JGY) 10-8	26	4.5	8.4
JM(JGY) 10-10	28	4.5	10.3
JM(JGY) 16-6	28.5	5.7	6.5
JM(JGY) 16-8	30.5	5.7	8.4
JM(JGY) 16-10	31	5.7	10.5
JM(JGY) 25-6	35	7.2	6.5
JM(JGY) 25-8	35	7.2	8.4
JM(JGY) 25-10	35	7.2	10.5
JM(JGY) 35-6	37.5	8.5	6.5
JM(JGY) 35-8	38	8.5	8.5
JM(JGY) 35-10	39	8.5	10.5
JM(JGY) 35-12	39	8.5	13
JM(JGY) 50-6	43.5	9.8	6.5
JM(JGY) 50-8	45	9.8	8.5
JM(JGY) 50-10	45	9.8	10.5
JM(JGY) 50-12	45	9.8	13
JM(JGY) 50-14	45	9.8	14.5
JM(JGY) 70-8	50	11.5	8.5
JM(JGY) 70-10	51.5	11.5	10.5
JM(JGY) 70-12	51.5	11.5	13
JM(JGY) 95-8	58.5	13.7	8.5
JM(JGY) 95-10	58.5	13.7	10.5
JM(JGY) 95-12	58.5	13.7	13
JM(JGY) 95-14	59	13.7	15

Modle	Dimensions(mm)		
	L	d	φ
JM(JGY) 120-10	63.5	15	10.5
JM(JGY) 120-12	65	15	13
JM(JGY) 120-14	65	15	14.7
JM(JGY) 120-16	66.5	15	17
JM(JGY) 150-10	73	16.7	10.5
JM(JGY) 150-12	73	16.7	13
JM(JGY) 150-14	73	16.7	14.7
JM(JGY) 150-16	73	16.7	17
JM(JGY) 185-10	80	19.2	10.5
JM(JGY) 185-12	80	19.2	13
JM(JGY) 185-14	80	19.2	14.7
JM(JGY) 185-16	80	19.2	17
JM(JGY) 240-12	92.5	21	13
JM(JGY) 240-14	92.5	21	14.7
JM(JGY) 240-16	92.5	21	17
JM(JGY) 240-20	94.5	21	21
JM(JGY) 300-12	102	24	13
JM(JGY) 300-16	102	24	17
JM(JGY) 300-20	105	24	21
JM(JGY) 400-16	114	27	17
JM(JGY) 400-20	116	27	21
JM(JGY) 500-16	127	30	17
JM(JGY) 500-20	127	30	21
JM(JGY) 630-16	140	35	17
JM(JGY) 630-20	140	35	21
JM(JGY) 630-22	140	35	23
JM(JGY) 800-22	170	39	23
JM(JGY) 1000-22	200	44	23

Cable lug



JM(JGA)

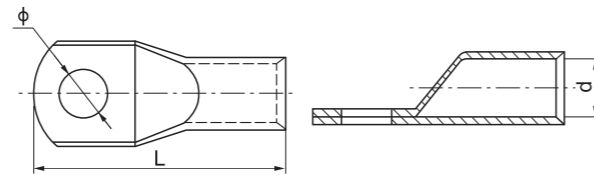

Material: E-Cu
 Surface treatment: Tin-plated
 Product Property: It is used to connect the copper conductor end.

Modle	Dimensions(mm)		
	L	d	φ
JM(JGA) 6-5	25	3.7	5.2
JM(JGA) 6-6	25	3.7	6.5
JM(JGA) 6-8	25	3.7	8.4
JM(JGA) 10-5	25	4.5	5.3
JM(JGA) 10-6	26	4.5	6.5
JM(JGA) 10-8	26	4.5	8.4
JM(JGA) 10-10	28	4.5	10.3
JM(JGA) 16-6	28.5	5.7	6.5
JM(JGA) 16-8	30.5	5.7	8.4
JM(JGA) 16-10	31	5.7	10.5
JM(JGA) 25-6	35	7.2	6.5
JM(JGA) 25-8	35	7.2	8.4
JM(JGA) 25-10	35	7.2	10.5
JM(JGA) 35-6	37.5	8.5	6.5
JM(JGA) 35-8	38	8.5	8.5
JM(JGA) 35-10	39	8.5	10.5
JM(JGA) 35-12	39	8.5	13
JM(JGA) 50-6	43.5	9.8	6.5
JM(JGA) 50-8	45	9.8	8.5
JM(JGA) 50-10	45	9.8	10.5
JM(JGA) 50-12	45	9.8	13
JM(JGA) 70-8	50	11.5	8.5
JM(JGA) 70-10	51.5	11.5	10.5
JM(JGA) 70-12	51.5	11.5	13
JM(JGA) 95-8	58.5	13.7	8.5
JM(JGA) 95-10	58.5	13.7	10.5
JM(JGA) 95-12	58.5	13.7	13
JM(JGA) 95-14	59	13.7	15
JM(JGA) 120-10	63.5	15	10.5
JM(JGA) 120-12	65	15	13

Modle	Dimensions(mm)		
	L	d	φ
JM(JGA) 120-14	65	15	14.7
JM(JGA) 120-16	66.5	15	17
JM(JGA) 150-10	73	16.7	10.5
JM(JGA) 150-12	73	16.7	13
JM(JGA) 150-14	73	16.7	14.7
JM(JGA) 150-16	73	16.7	17
JM(JGA) 185-10	80	19.2	10.5
JM(JGA) 185-12	80	19.2	13
JM(JGA) 185-14	80	19.2	14.7
JM(JGA) 185-16	80	19.2	17
JM(JGA) 185-20	81.5	19.2	21
JM(JGA) 240-12	92.5	21	13
JM(JGA) 240-14	92.5	21	14.7
JM(JGA) 240-16	92.5	21	17
JM(JGA) 240-20	94.5	21	21
JM(JGA) 300-12	102	24	13
JM(JGA) 300-14	102	24	14.7
JM(JGA) 300-16	102	24	17
JM(JGA) 300-20	105	24	21
JM(JGA) 400-16	114	27	17
JM(JGA) 400-20	116	27	21
JM(JGA) 500-16	127	30	17
JM(JGA) 500-20	127	30	21
JM(JGA) 630-16	140	35	17
JM(JGA) 630-20	140	35	21
JM(JGA) 630-22	140	35	23
JM(JGA) 800-22	170	39	23
JM(JGA) 1000-22	200	44	23

Cable lug



JM(JGB)

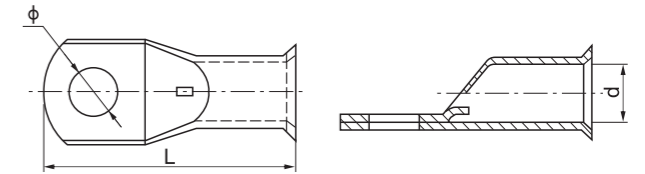

Material: E-Cu
 Surface treatment: Tin-plated
 Product Property: It is used to connect the copper conductor end. It has a viewing window to check the conductor location. And its bell mouth is specially designed to accommodate fine strand flexible conductors. Because fine stranded cables have a larger diameter than normal cables. And they tend to splay out after stripping, JGB lugs which funnel the strands into the lug and make conductor insert easily.

Modle	Dimensions(mm)		
	L	d	φ
JM(JGB) 6-5	25	3.7	5.2
JM(JGB) 6-6	25	3.7	6.5
JM(JGB) 6-8	25	3.7	8.4
JM(JGB) 10-6	26	4.5	6.5
JM(JGB) 10-8	26	4.5	8.4
JM(JGB) 10-10	28	4.5	10.3
JM(JGB) 16-6	28.5	5.7	6.5
JM(JGB) 16-8	30.5	5.7	8.4
JM(JGB) 16-10	31	5.7	10.5
JM(JGB) 25-6	33.5	7.2	6.5
JM(JGB) 25-8	35	7.2	8.4
JM(JGB) 25-10	35	7.2	10.5
JM(JGB) 35-6	37.5	8.5	6.5
JM(JGB) 35-8	38	8.5	8.5
JM(JGB) 35-10	39	8.5	10.5
JM(JGB) 35-12	39	8.5	13
JM(JGB) 50-6	43.5	9.8	6.5
JM(JGB) 50-8	45	9.8	8.5
JM(JGB) 50-10	45	9.8	10.5
JM(JGB) 50-12	45	9.8	13
JM(JGB) 70-8	50	11.5	8.5
JM(JGB) 70-10	51.5	11.5	10.5
JM(JGB) 70-12	51.5	11.5	13
JM(JGB) 95-10	58.5	13.7	10.5

Modle	Dimensions(mm)		
	L	d	φ
JM(JGB) 95-12	58.5	13.7	13
JM(JGB) 120-12	65	15	13
JM(JGB) 120-14	65	15	14.7
JM(JGB) 120-16	66.5	15	17
JM(JGB) 150-10	73	16.7	10.5
JM(JGB) 150-12	73	16.7	13
JM(JGB) 150-14	73	16.7	14.7
JM(JGB) 150-16	73	16.7	17
JM(JGB) 185-12	80	19.2	13
JM(JGB) 185-14	80	19.2	14.7
JM(JGB) 185-16	80	19.2	17
JM(JGB) 240-16	92.5	21	17
JM(JGB) 240-20	92.5	21	21
JM(JGB) 300-16	---	24	---
JM(JGB) 300-20	---	24	---
JM(JGB) 400-16	---	27	---
JM(JGB) 400-20	---	27	---
JM(JGB) 500-16	---	30	---
JM(JGB) 500-20	---	30	---
JM(JGB) 630-20	---	35	---
JM(JGB) 630-22	---	35	---
JM(JGB) 800-22	---	39	---
JM(JGB) 1000-22	---	44	---

Circuit breaker lug



TM

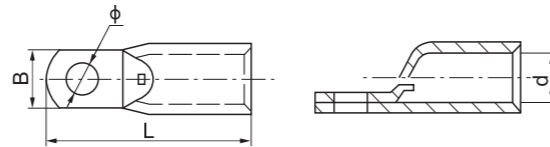

Material: E-Cu
 Surface treatment: Tin-plated mini 3 microns
 Product Property: For smaller contact area or space, such as a connection of MCCB, a narrow palm lug is required. TM is special designed for such a connection.

Modle	Dimensions(mm)			
	L	d	B	φ
TM 10-5	27	4.3	9	5.3
TM 16-5	31	5.6	9	5.3
TM 25-5	35	7	9	5.3
TM 35-6	40.5	8.4	11.5	6.4
TM 50-8	45.5	9.5	12.8	8.4
TM 70-8	49	11.2	12.8	8.4
TM 95-8	54	13.5	15.5	8.4
TM 120-8	68	15.6	19	8.4

Modle	Dimensions(mm)			
	L	d	B	φ
TM 120-10	68	15.6	19	10.5
TM 150-8	75	16.7	19	8.4
TM 150-10	75	16.7	19	10.5
TM 185-10	79	19	24.5	10.5
TM 240-10	86	21.1	29.8	10.5
TM 240-12	92	21.1	29.8	13.2
TM 240-16	100	21.1	29.8	17
TM 300-12	97	23.7	31	13.2

Din aluminium lug



AU

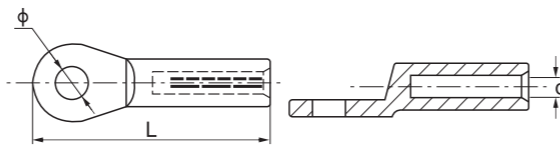

Material: A1-99.5%
 Surface treatment: Tin-plated mini 15 microns
 Product Property: It is in accordance with DIN 46329 with markings for correct crimping. And its barrel capped is filled with joint compound to avoid oxidization. And its type test is follow IEC 61238-1.

Modle	Dimensions(mm)		
	L	d	φ
AU 16-8	60	5.8	8.4
AU 25-8	61.5	6.8	8.4
AU 25-10	61.5	6.8	10.5
AU 35-10	77	8	10.5
AU 50-10	77	9.8	10.5
AU 50-12	77	9.8	13
AU 70-10	84.5	11.2	10.5
AU 95-12	88	13.2	13

Modle	Dimensions(mm)		
	L	d	φ
AU 120-12	95	14.7	13
AU 150-12	105	16.3	13
AU 150-16	105	16.3	17
AU 185-12	106	18.3	13
AU 185-16	106	18.3	17
AU 240-12	122	21	13
AU 240-16	122	21	17
AU 300-16	123	23.3	17

Din cable lug



AUS

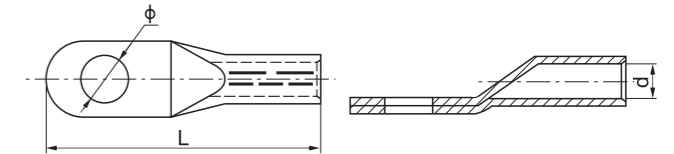

Material: E-Cu
 Surface treatment: Tin-plated mini 8 microns
 Product Property: It is used to connect the copper conductor end. Application up to 33kv. It is in accordance with DIN46235 with markings for correct crimping. And its type test is follow IEC 61238-1.

Modle	Dimensions(mm)		
	L	d	φ
AUS 6-5	30.5	30.5	5.3
AUS 6-6	31.5	3.8	6.4
AUS 6-8	34	3.8	8.4
AUS 10-5	34	4.5	5.3
AUS 10-6	34.5	4.5	6.4
AUS 10-8	37	4.5	8.4
AUS 16-6	43.5	5.5	6.4
AUS 16-8	46	5.5	8.4
AUS 16-10	48	5.5	10.5
AUS 16-12	49	5.5	13
AUS 25-6	45.5	7	6.4
AUS 25-8	48	7	8.4
AUS 25-10	50	7	10.5
AUS 25-12	51	7	13
AUS 35-6	49.5	8.4	6.4
AUS 35-8	52	8.4	8.4
AUS 35-10	54	8.4	10.5
AUS 35-12	55	8.4	13
AUS 35-14	56.5	8.2	15
AUS 50-8	62	10	8.4
AUS 50-10	64	10	10.5
AUS 50-12	65	10	13
AUS 50-14	66.5	10	15
AUS 50-16	68	10	17
AUS 70-8	65	11.5	8.4
AUS 70-10	67	11.5	10.5
AUS 70-12	68	11.5	13
AUS 70-14	69.5	11.5	15
AUS 70-16	71	11.5	17
AUS 95-8	77	13.5	8.4
AUS 95-10	77	13.5	10.5
AUS 95-12	78	13.5	13
AUS 95-14	79.5	13.5	15
AUS 95-16	81	13.5	17

Modle	Dimensions(mm)		
	L	d	φ
AUS 120-10	85	15.5	10.5
AUS 120-12	86	15.5	13
AUS 120-14	88	15.5	15
AUS 120-16	89	15.5	17
AUS 120-20	91	15.5	21
AUS 150-10	93	17	10.5
AUS 150-12	94	17	13
AUS 150-14	97	17	15
AUS 150-16	97	17	17
AUS 150-20	99	17	21
AUS 185-10	97	19	10.5
AUS 185-12	98	19	13
AUS 185-14	101	19	15
AUS 185-16	101	19	17
AUS 185-20	103	19	21
AUS 240-12	108	21.5	13
AUS 240-14	111	21.5	15
AUS 240-16	111	21.5	17
AUS 240-20	113	21.5	21
AUS 300-14	119	24.5	15
AUS 300-16	119	24.5	17
AUS 300-20	122	24.5	21
AUS 400-14	140	27.5	15
AUS 400-16	140	27.5	17
AUS 400-20	140	27.5	21
AUS 500-16	150	31	17
AUS 500-20	150	31	21
AUS 630-16	160	34.5	17
AUS 630-20	160	34.5	21
AUS 800-16	195	40	17
AUS 800-20	195	40	21
AUS 1000-16	195	44	17
AUS 1000-20	195	44	21

Cable lug



DT

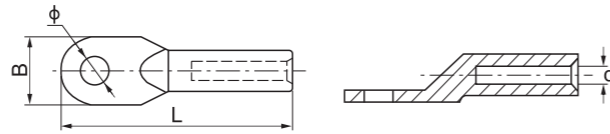

Material: E-Cu
 Surface treatment: Bright
 Product Property: It is used to connect the copper conductor end.

Modle	Dimensions(mm)			
	L	d	B	φ
DT 10-6	59	4.7	13.5	6.5
DT 16-8	67	5.7	16	8.5
DT 25-8	70	7.2	17.5	8.5
DT 35-10	78	8.5	20	10.5
DT 50-10	87	9.7	23	10.5
DT 70-12	95	11.5	26	12.5
DT 95-12	105	13.5	28	12.5
DT 120-14	112	15	31	14.5
DT 150-14	116	16.5	35	14.5
DT 185-16	125	18.5	37.5	17
DT 240-16	134	21	40	17
DT 300-18	150	23.5	44.5	18.5
DT 400-20	160	26.5	50	21

Aluminium lug



DL

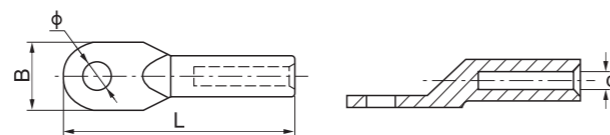

Material: A1-99.5%
 Surface treatment: Bright
 Products property: It is used to connect the aluminum conductor end.

Modle	Dimensions(mm)			
	L	d	B	φ
DL 16-6	70	5.8	16	6.5
DL 16-8	70	5.8	16	8.5
DL 25-8	75	7.2	17.5	8.5
DL 35-8	85	8.5	20	8.5
DL 35-10	85	8.5	20	10.5
DL 50-10	90	9.7	23	10.5
DL 70-12	100	11.5	26	12.5
DL 95-12	110	13.5	28	12.5

Modle	Dimensions(mm)			
	L	d	B	φ
DL 120-14	120	15	31	14.5
DL 150-14	125	16.5	35	14.5
DL 150-16	125	16.5	35	17
DL 185-16	133	18.5	37.5	17
DL 240-16	140	21	40	17
DL 300-18	160	23.5	44.5	18.5
DL 300-20	160	23.5	44.5	21

Bimetal lug



DTL

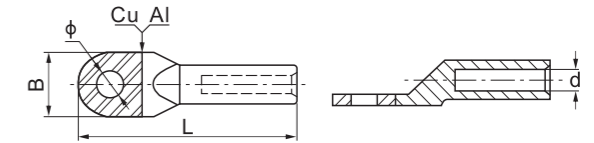

Material: E-Cu; A1-99.6%
 Surface treatment: Bright
 Products property: Due to the coupling effect when Aluminium comes in contact with Copper, corrosion will happen in a short time. Currently the best solution is to use Aluminium-Copper bimetal connectors. A bimetal lug should be used for termination. The friction welding is well done. And its barrel capped is filled with joint compound to avoid oxidization.

Modle	Dimensions(mm)			
	L	d	B	φ
DTL 10-6	62	4.8	13.5	6.5
DTL 16-8	70	5.8	16	8.5
DTL 25-8	75	7.2	17.5	8.5
DTL 35-10	85	8.5	20	10.5
DTL 50-10	90	9.7	23	10.5
DTL 70-12	102	11.5	26	12.5
DTL 95-12	112	13.5	28	12.5

Modle	Dimensions(mm)			
	L	d	B	φ
DTL 120-14	120	15	31	14.5
DTL 150-14	125	16.5	35	14.5
DTL 185-16	133	18.5	37.5	17
DTL 240-16	140	21	40	17
DTL 300-18	160	23.5	44.5	18.5
DTL 400-20	170	27	50	21
DTL 500-20	225	29	60	21

Bimetal lug a type



DTL-2

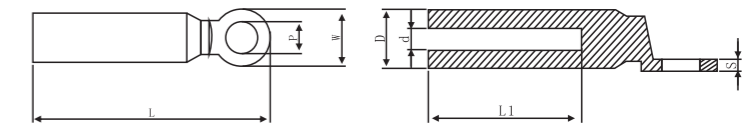

Material: E-Cu; A1-99.6%
 Surface treatment: Bright
 Products property: Due to the coupling effect when Aluminium comes in contact with Copper, corrosion will happen in a short time. Currently the best solution is to use Aluminium-Copper bi-metal connectors. A bimetal lug should be used for termination. The friction welding is well done. And its barrel capped is filled with joint compound to avoid oxidization. The type test is follow IEC 61238-1.

Type A(mm)	Dimensions(mm)						
	P±0.3	D±0.5	d±0.3	L±3	L1±0.3	W±0.5	S±0.3
DTL-2-16-11	Φ11	Φ16	Φ6	80	40	Φ20	3
DTL-2-25-11	Φ11	Φ16	Φ7	80	40	Φ20	3
DTL-2-35-11	Φ11	Φ16	Φ8.5	80	40	Φ20	3
DTL-2-50-13	Φ13	Φ20	Φ10	90	43	Φ25	4.5
DTL-2-70-13	Φ13	Φ20	Φ11.5	90	43	Φ25	4.5
DTL-2-95-13	Φ13	Φ20	Φ13.5	90	43	Φ25	4.5
DTL-2-120-13	Φ13	Φ25	Φ15	115	59	Φ30	5.5
DTL-2-150-13	Φ13	Φ25	Φ16.5	115	59	Φ30	5.5

Type A(mm)	Dimensions(mm)						
	P±0.3	D±0.5	d±0.3	L±3	L1±0.3	W±0.5	S±0.3
DTL-2-185-13	Φ13	Φ32	Φ18.5	122	60	Φ30	6
DTL-2-240-13	Φ13	Φ32	Φ21	122	60	Φ35	6
DTL-2-300-13	Φ13	Φ34	Φ23.5	128	65	Φ35	6
DTL-2-400-17	Φ17	Φ40	Φ26	160	90	Φ36	6
DTL-2-500-17	Φ17	Φ40	Φ30	160	95	Φ36	6
DTL-2-630-17	Φ17	Φ47	Φ33.5	205	95	Φ60	10
DTL-2-800	Φ17	Φ60	Φ38.5	240	110	Φ80	10
DTL-2-1000	Φ17	Φ60	Φ43.5	240	110	Φ80	10

Bimetal lug b type



CAL-BS

Material: E-Cu; Al-99.6%
Surface treatment: Bright

Products property: Due to the coupling effect when Aluminium comes in contact with Copper, corrosion will happen in a short time. Currently the best solution is to use Aluminium-Copper bi-metal connectors. A bimetal lug should be used for termination. The friction welding is well done. And its barrel capped is filled with joint compound to avoid oxidization. The type test is follow IEC 61238-1. We are able to produce special bimetal lugs on request.

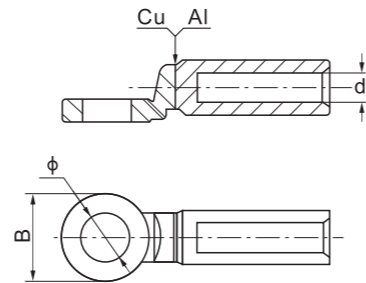

Modle	Dimensions(mm)		
	d	B	φ
CAL-16BS-10	5.6	20	10.5
CAL-25BS-10	6.5	20	10.5
CAL-35BS-10	8.5	20	10.5
CAL-50BS-12	9.5	24	12.8
CAL-70BS-12	11	24	12.8
CAL-95BS-12	12.5	24	12.8
CAL-120BS-12	13.7	30	12.8

Modle	Dimensions(mm)		
	d	B	φ
CAL-150BS-12	15.5	30	12.8
CAL-185BS-12	17	35	12.8
CAL-240BS-12	19.5	35	12.8
CAL-300BS-16	23.3	36	16.5
CAL-400BS-16	26	36	16.5
CAL-500BS-16	29	60	17
CAL-630BS-16	32.5	60	17

Bimetal lug



ATL

Material: E-Cu; Al-99.5%
Surface treatment: Bright

Products property: It is used for screwing non-tension aluminium connections using copper washers.

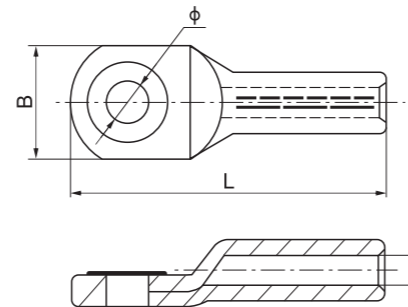

Modle	Dimensions(mm)			
	L	d	B	φ
ATL 10-6	63	5	18	6.5
ATL 10-8	63	5	22	8.5
ATL 16-8	63	5.8	22	8.5
ATL 16-10	65	5.8	25	10.5
ATL 25-8	71	6.8	22	8.5
ATL 25-10	73	6.8	25	10.5
ATL 25-12	73	6.8	27.5	13
ATL 35-8	79	8	22	8.5
ATL 35-10	80	8	26	10.5
ATL 35-12	82.5	8	30	13
ATL 50-8	84.5	9.8	25	8.5
ATL 50-10	86	9.8	27	10.5
ATL 50-12	87.5	9.8	30	13
ATL 70-8	98.5	11.2	28	8.5
ATL 70-10	100	11.2	29	10.5
ATL 70-12	102.5	11.2	32	13
ATL 95-10	106.5	13.2	32	10.5
ATL 95-12	106.5	13.2	35	13

Modle	Dimensions(mm)			
	L	d	B	φ
ATL 95-16	108.5	13.2	38	17
ATL 120-10	107.5	14.7	34	10.5
ATL 120-12	107.5	14.7	35	13
ATL 120-16	109.5	14.7	38	17
ATL 150-10	119	16.3	35	10.5
ATL 150-12	119	16.3	35	13
ATL 150-16	121.5	16.3	41	17
ATL 150-20	123	16.3	44	21
ATL 185-12	123.5	18.3	40	13
ATL 185-16	124.5	18.3	42	17
ATL 185-20	126	18.3	46	21
ATL 240-12	136	21	45	13
ATL 240-16	136	21	45	17
ATL 240-20	136	21	49	21
ATL 300-16	144	23.3	51	17
ATL 300-20	145	23.3	51	21
ATL 400-16	187	26	58	17
ATL 400-20	187	26	58	21

Mechanical Lugs and Connectors



AML

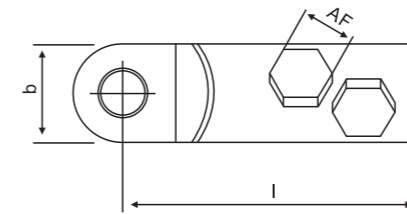

Characteristics:

1. Total cross-section: 25-400 mm
2. Pr-engineered design for perfect fit in medium voltage cable accessories upto 42 kV.
3. Lugs are suitable for out door and indoor applications.
4. Connector and lug bodies are made of a high-tensile, tin plated aluminium alloy.
5. Lugs are suitable for outdoor and indoor applications and are available with different hole sizes.

Cable Size (mm ²)	Bolt Size	Code	Dimension (mm)			Bolt Quantity
			b	I	AF	
25-95	M-12	AML25/95-13	24	60	13	1
	M-16	AML25/95-17				
35-150	M-12	AML35/150-13	28	86	16	1
	M-16	AML35/150-17				
95-240	M-12	AML95/240-13	33	112	19	2
	M-16	AML95/240-17				
	M-20	AML95/240-21				
120-300	M-12	AML120/300-13	37	115	24	2
	M-16	AML120/300-17				
185-400	M-12	AML185/240-13	42	137	24	3
	M-16	AML185/240-17				
	M-20	AML185/240-21				

Mechanical Lugs and Connectors



AMO

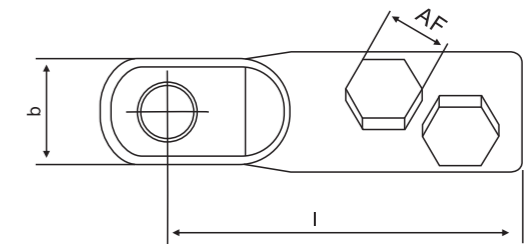

Characteristics:

1. Total cross-section: 25-400 mm
2. Pre-engineered design for perfect fit in medium voltage cable accessories up to 42 kV.
3. Lugs are suitable for out door and indoor applications.
4. Connector and lug bodies are made of a high-tensile, tin plated aluminium alloy.
5. Use in cable accessories.

Cable Size(mm ²)	Size of Bolt	Code	Dimension (mm)			Bolt Quantity
			b	I	AF	
25-95	M16	AMO25/95-16	34	80	13	1
95-240	M16	AMO95/240-16	34	120	19	2
185-300	M16	AMO185/300-16	34	115	22	2
240-400	M16	AMO240/400-16	34	115	24	3

Bolted brass lug



WCJC

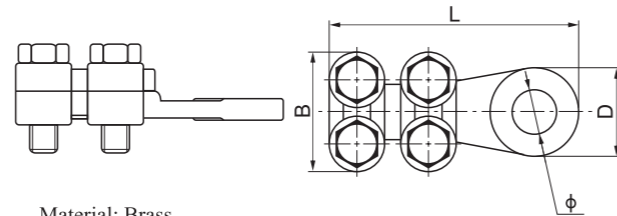

Material: Brass
 Surface treatment: Nickle plated
 Products property: It is fixed by bolts and used in the connections between the electrical equipment with cable and the indoor distribution equipment. They can be reused many times.

Modle	Dimensions(mm)			
	L	D	B	φ
WCJC 16-8	37	16	21.5	8
WCJC 25-35-10	48	22	23	11
WCJC 50-70-10	61	23	30	11
WCJC 70-95-12	66.5	27	33	13
WCJC 120-150-14	73	32	36	15
WCJC 185-240-16	91	39	46	17
WCJC 300-20	105	45.5	55	21
WCJC 400-22	122	50	60	23

Bolted copper lug



WCJB

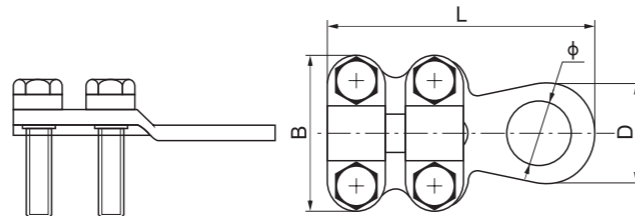

Material: E-Cu
 Surface treatment: Tin plated
 Products property: It is fixed by bolts and used in the connections between the electrical equipment with cable and the indoor distribution equipment. It can be reused many times.

Modle	Dimensions(mm)			
	L	d	B	φ
WCJB 6-10-6	31	15	18.5	6.5
WCJB 16-25-8	46	18.5	24	8.5
WCJB 25-35-10	53	21.5	24	10.5
WCJB 50-70-10	63	23.5	31	10.5
WCJB 70-95-12	69	24	34	13
WCJB 120-150-12	76	30	42	13
WCJB 120-150-16	76	30	42	17
WCJB 185-240-16	85.5	34	48.5	17
WCJB 185-240-20	88.5	36	48.5	21
WCJB 240-300-20	87	34.5	50.5	21

Span Parallel Groove Clamp(JBL、JBT、JBTL)(Equivalent Model:JBL)

Outline and installation dimension

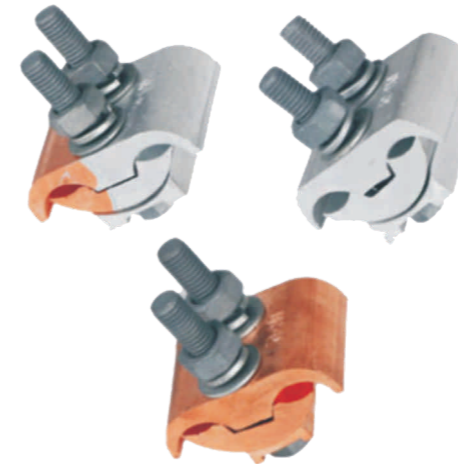

Note:

- The meaning of model letters and numbers in the table is: J means continuation, B stands for parallel groove, t stands for copper, I stands for aluminum, and no letter stands for aluminum, Q is brazing type;
- The additional number "2" or no additional number means two bolts, The number "3" indicates three bolts.

Model	Applicable Traverse Section(mm ²)
JBL-16-120/2	16-120
JBL-16-120/3	16-120
JBL-50-240/2	50-240
JBL-50-240/3	50-240
JBL-120-400/2	120-400
JBL-120-400/3	120-400
JBL-16-120(3)	35-120
JBL-95-300(3)	95-300
JBL-50-240(3)	50-240
JBL-16-120(2)	16-120
JBL-50-240	50-240
JBT-10-70	10-70
JBT-16-120	16-120
JBT-50-240	50-240
JBTL-10-70	10-70
JBTL-16-120	16-120
JBTL-50-240	50-240
JBTL-16-120Q	16-120
JBTL-50-120Q	50-240

JB/JBT/JBTL Series Copper parallel Groove Clamp

Outline and installation dimension

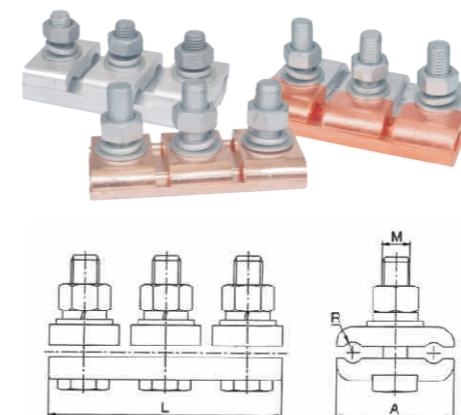

Model	Applicable Traverse Section(mm ²)	Bolt Quantity	Dimensions(mm)			
			M	D	B	A
JB/JBT/JBTL-0	16-25	12	12	22	7	50
JB/JBT/JBTL-1	35-50	14	14	26	7	50
JB/JBT/JBTL-2	70-95	16	16	26	7	50
JB/JBT/JBTL-3	120-150	18	18	30	8	60
JB/JBT/JBTL-4	185-240	20	20	30	8	60

ST/SL Series Bolt Type Equipment Clamp

Outline and installation dimension

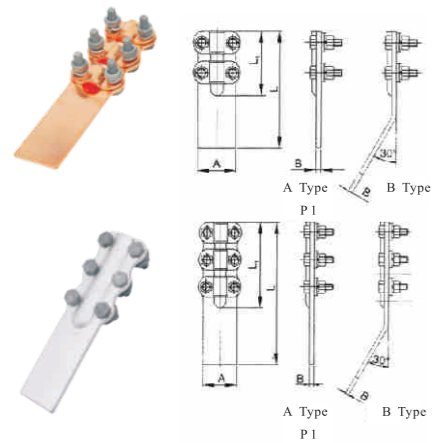

Model	Applicable Traverse Section(mm ²)	Dimensions(mm)			
		B	A	L1	L2
/	35-50 P1	4.5	40	65	120
/	70-95 P1	4.5	40	80	136
ST/SL-1A(B)	35-50 P1	4.5	40	65	145
ST/SL-2A(B)	70-95 P1	4.5	40	80	175
ST/SL-3A(B)	120-150 P2	5	50	125	225
ST/SL-4A(B)	185-240 P2	5	50	125	225
ST/SL-5A(B)	300-400 P2	6	63	130	245
ST/SL-2A(B)-80	70-95 P1	5	80	80	185
ST/SL-3A(B)-80	120-150 P2	5	80	125	239
ST/SL-4A(B)-80	185-240 P2	5	80	125	239
ST/SL-5A(B)-80	300-400 P2	8	80	130	245
ST/SL-2A(B)-100	70-95 P1	6	100	80	205
ST/SL-3A(B)-100	120-150 P2	6	100	125	260
ST/SL-4A(B)-100	185-240 P2	6	100	125	260
ST/SL-5A(B)-100	300-400 P2	8	100	130	260
ST/SL-6A(B)-100	500-630 P2	8	100	130	260

- Note:
- The additional number A indicates level 0° , B means 30° .
 - Note 1 for the terminal board is recommended for single hole, Note 2 for double breasts, and Note 3 for four holes.
 - If the size of the terminal board required by the user is different from that in the table, please specify it when ordering.

SLG-(A, B) Series Bolt Type Copper Aluminum Transition Equipment Clamp

Outline and installation dimension

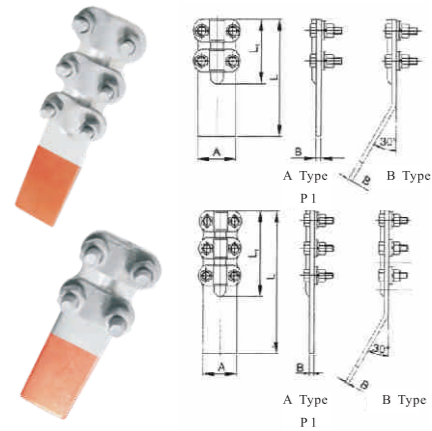

Model	Applicable Traverse Section(mm ²)	Dimensions(mm)			
		B	A	L1	L2
/	35-50 P1	5	40	65	42
/	70-95 P1	5	40	80	45
SLG-1	35-50 P1	5	40	65	60
SLG-2	70-95 P1	5	40	80	60
SLG-3-80	120-150 P2	6	80	125	85
SLG-4-80	185-240 P2	6	80	125	85
SLG-1(98)	300-400 P1	6.3	40	65	65
SLG-2(98)	70-95 P1	6.3	40	80	80
SLG-3(98)	120-150 P2	6.3	50	125	85
SLG-4(98)	185-240 P2	6.3	50	125	85

- Note:
- The additional number A indicates level 0° , B means 30° .
 - Note 1 for the terminal board is recommended for single hole, Note 2 for double breasts, and Note 3 for four holes.
 - If the size of the terminal board required by the user is different from that in the table, please specify it when ordering.

SLG-F Series Bolt Type Copper Aluminum Composite Transition Equipment Clamp

Outline and installation dimension

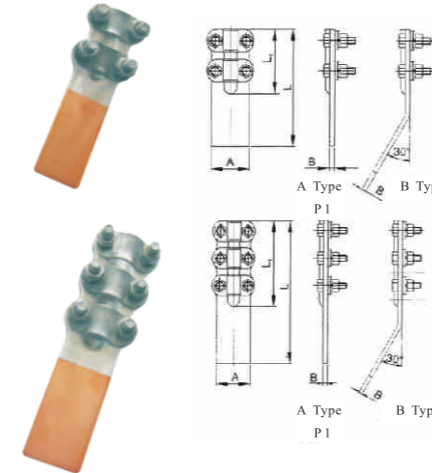

Model	Applicable Traverse Section(mm ²)	Dimensions(mm)				
		B	A	L1	L2	L
SLG-1F	35-50 P1	6(5)	40	65	65	145
SLG-2F	70-95 P1	6(5)	40	80	80	175
SLG-3F	35-50 P1	6.3	50	125	85	225
SLG-4F	70-95 P1	6.3	50	125	85	225
SLG-3F-80	120-150 P2	6.3	80	125	85	225
SLG-3F-80	185-240 P2	6.3	80	125	85	225

- Note: Note 1 for the terminal board is recommended for single hole, for Note 2 for double holes, and for Note 3 for four holes.

SLG-Q Series Bolt Type Copper Aluminum Composite Transition Equipment Clamp(Brazing)

Outline and installation dimension

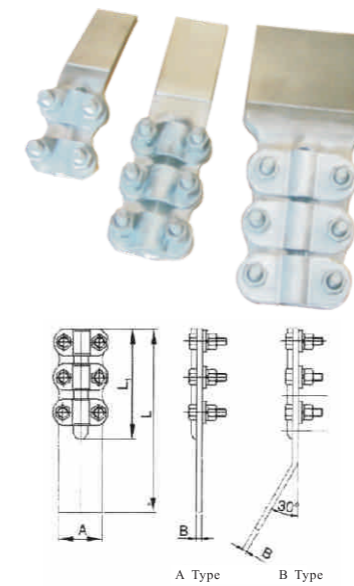

Model	Applicable Traverse Section(mm ²)	Dimensions(mm)				
		B	A	L1	L2	L
/	35-50	6	40	65	45	120
/	70-95	6	40	65	45	136
SLG-1Q	35-50	6	40	80	65	145
SLG-2Q	70-95	6	40	65	80	175
SLG-2Q-80	70-95	8	80	80	80	185
SLG-3Q-80	70-95	10	100	80	100	205
SLG-3Q	120-150	8	50	80	85	225
SLG-3Q-63	120-150	8	63	125	85	239
SLG-3Q-80	120-150	8	80	125	85	239
SLG-3Q-100	120-150	10	100	125	100	2960
SLG-4Q	185-240	8	50	125	85	225
SLG-4Q-63	185-240	8	63	125	85	239
SLG-4Q-80	185-240	8	80	125	85	239
SLG-4Q-100	185-240	10	100	125	100	260
SLG-5Q	300-400	10	63	130	85	245
SLG-5Q-80	300-400	10	80	130	85	245
SLG-5Q-100	300-400	10	100	130	100	260

- Note:
- Note 1 for the terminal board is recommended for single hole, for Note 2 for double holes, and for Note 3 for four holes.

JKG Series Low Voltage Household Clamp

Outline and installation dimension



Model	Applicable Traverse Section(mm ²)	
	Thread	Feeder line
JKG-1	16-70	4-16
JKG-2	35-150	4-25
JKG-3	25-150	25-35

JBY Torque Type Span Clamp(Equivalent Model:JBL、PGA)

Outline and installation dimension

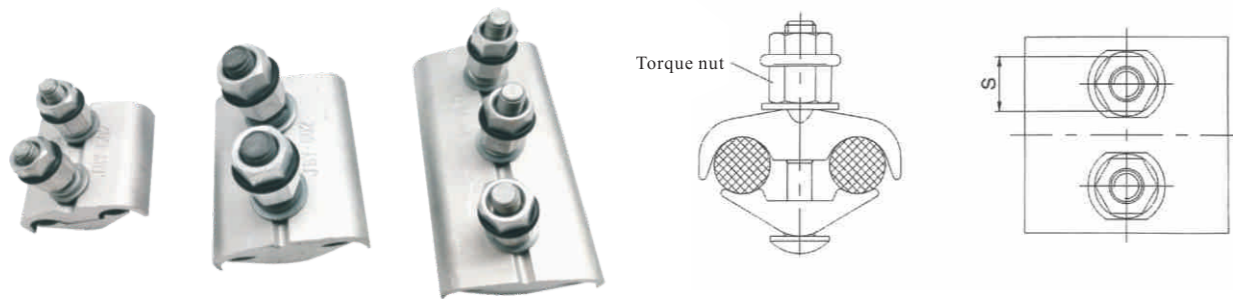

Model	Applicable Traverse Section(mm ²)	Applicable Branch Section(mm ²)	Conductor Diameter Range	Bolt Quantity	S	Installation torque N.w	Equivalent Model
JBY-302	10-95	10-95	Φ 3.8-12.0	2xM8	14	25±3	PGA-302、JBL-0
JBY-502	25-150	25-70	Φ 6.0-16.0	2xM8	14	35±4	PGA-502
JBY-503	25-150	25-150	Φ 6.0-16.0	3xM8	14	35±4	PGA-502、JBL-1
JBY-602	50-240	50-120	Φ 8.3-18.4	2xM12	19	50±5	PGA-602
JBY-603	50-240	50-240	Φ 8.3-18.4	3xM12	19	50±5	PGA-603、JBL-2
JBY-803	95-300	95-300	Φ 11.6-23.0	3xM12	19	50±5	PGA-803、JBL-3

NXJG Wedge Type Insulated Strain Clamp(Used For JKLYJ Insulated Cable of Aluminum Strand Frame-Handing Plate)

Outline and installation dimension

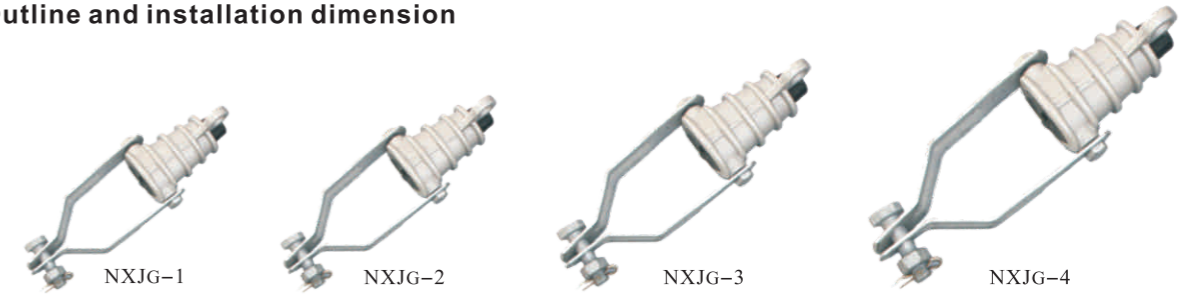

Model	Applicable Traverse	Applicable Traverse Section (overhead insulated aluminum conductor)		Applicable Traverse Section (overhead insulated aluminum conductor)		Conductor Diameter Range	Specified Failure Load(kN)
		(Dia mm)	Wedge core selection	(Dia mm)	Wedge core selection		
NXJG-1	35	9.8	1kV/35	15.8	10kV/35	3.4	7.5
NXJG-1	50	11.2	1kV/50	17.1	10kV/50	4.6	7.5
NXJG-2	70	12.8	1kV/70	18.8	10kV/70	6.7	14.5
NXJG-2	95	14.8	1kV/95	20.4	10kV/95	8.9	14.5
NXJG-3	120	16.2	1kV/120	21.8	10kV/120	11.3	22.1
NXJG-3	150	18.2	1kV/150	23.4	10kV/150	13.7	22.1
NXJG-4	185	20.2	1kV/185	25.0	10kV/185	17.3	36.4
NXJG-4	240	22.6	1kV/240	27.2	10kV/240	22.5	36.4

NXL Series Wedge Type Strain Clamp

Outline and installation dimension



Model	Applicable Traverse Section (overhead insulated aluminum conductor)	Length(mm ²)	Conductor Diameter Range	Specified Failure Load(kN)	InsulationCover Type
NXL-1J	10kV/35	/	3.4	14.5	NXL-2J
NXL-1J	10kV/50	/	4.6	14.5	NXL-2J
NXL-2J	10kV/70	/	6.7	14.5	NXL-2J
NXL-2J	10kV/95	/	8.9	23.4	NXL-3J
NXL-3J	10kV/120	/	11.3	23.4	NXL-3J
NXL-3J	10kV/150	/	13.7	23.4	NXL-3J
NXL-4J	10kV/185	/	17.3	36.4	NXL-4J
NXL-4J	10kV/240	/	22.5	36.4	NXL-4J

SYG Series Copper Aluminum Compression Type Equipment Clamp

Outline and installation dimension

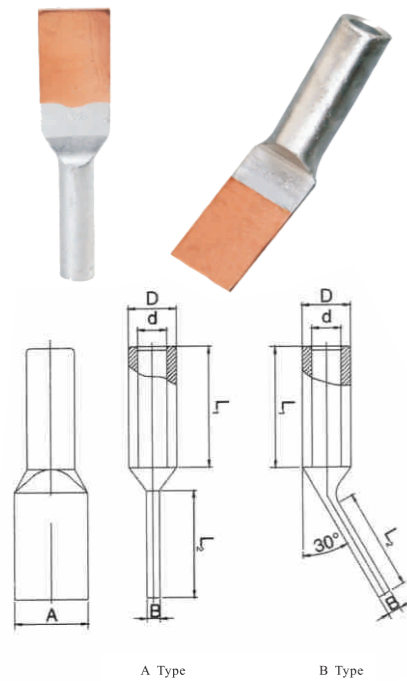

Model	Dimensions(mm)					
	d	D	L1	L2	A	B
SYG-35	8.8	14	40	50	28	4.0
SYG-50	10	16	45	55	28	4.8
SYG-70	11.8	18	53	65	34	5.0
SYG-95	14.0	20	58	70	40	5.0
SYG-120	15.5	22	63	70	40	5.5
SYG-150	17.0	25	68	75	50	6.5
SYG-185	19.0	27	73	80	50	7.3
SYG-240	21.0	30	78	85	50	8.5
SYG-300	23.0	32	88	90	60	9.0
SYG-400	26.5	35	88	100	60	9.0
SYG-500	30.0	38	98	100	80	9.0
SYG-630	35.0	45	95	100	80	12.0
SYG-800	38.5	50	103	200	100	12.5

SY(T) Series Compression Type Equipment Clamp A(B)

Outline and installation dimension

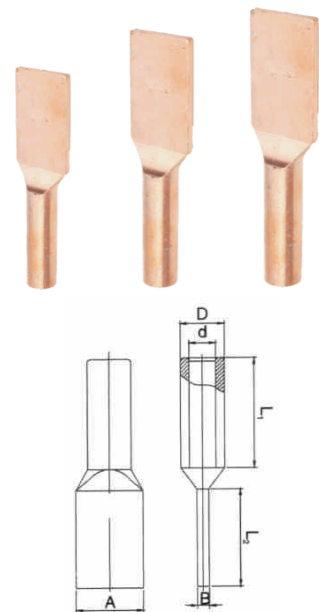

Model	Dimensions(mm)				
	d	D	L1	L2	A
SY(T)-35	8.8	14	40	50	28
SY(T)-50	10	16	45	55	28
SY(T)-70	11.8	18	53	65	34
SY(T)-95	14.0	20	58	70	40
SY(T)-120	15.5	22	63	70	40
SY(T)-150	17.0	25	68	75	50
SY(T)-185	19.0	27	73	80	50
SY(T)-240	21.0	30	78	85	50
SY(T)-300	23.0	32	88	90	60
SY(T)-400	26.5	35	88	100	60
SY(T)-500	30.0	38	98	100	80
SY(T)-630	35.0	45	95	100	80
SY(T)-800	38.5	50	103	200	100



POWER CONNECTORS

Split bolt

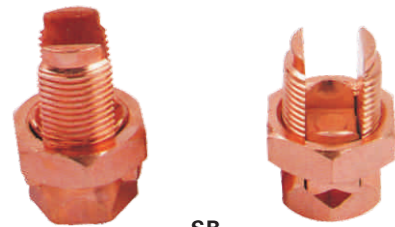

SB

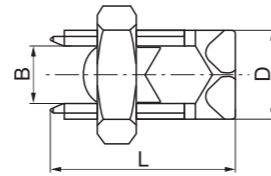

Material: Brass
 Surface treatment: Tin plated or copper plated on request
 Product Property: It is used to branch or connect aerial hard copper conductor or insulated copper conductor.

Modle	Dimensions(mm)			
	L	D	B	Screw Thread
SB 16-35	38	17	8.5	5/8-18UNF-2A
SB 25-50	42	19	10	3/4-16UNF-2A
SB 50-70	46	21	11	3/4-16UNF-2A
SB 95-120	50	26	14.5	1-12UNF-2A
SB 150-185	60	30	17.2	1 ³ / ₁₆ -12UNF-2A
SB 200-240	65	32	19.3	1 ¹ / ₄ -12UNF-2A
SB 10	27	13	5	1/2-20UNF-2A
SB 16	30	14	6	G1/4
SB 25	32	17	7	5/8-18UNF-2A

Modle	Dimensions(mm)			
	L	D	B	Screw Thread
SB 35	38	17	8.5	5/8-18UNF-2A
SB 50	42	19	10	3/4-16UNF-2A
SB 70	46	21	11	3/4-16UNF-2A
SB 95	46	26	13.3	1-12UNF-2A
SB 120	50	26	14.5	1-12UNF-2A
SB 150	55	30	16.5	1 ³ / ₁₆ -12UNF-2A
SB 185	60	30	17.2	1 ³ / ₁₆ -12UNF-2A
SB 240	65	32	19.3	1 ¹ / ₄ -12UNF-2A

U-T Type connector



U-T

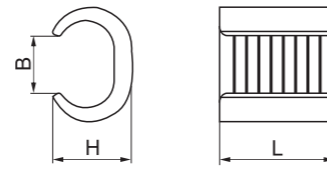

Material: E-Cu
 Surface treatment: Tin plated mini 3 microns
 Product Property: Dimpled and serrated to obtain high pull-out value. Chamfered edges designed to protect the wire.

Modle	Dimensions(mm)			Conductor Cross-section (mm ²)
	L	B	H	
U-T44	20	8.3	14	27-44
U-T60	22.5	10.8	15	45-60
U-T76	22.5	9.5	17	61-76
U-T98	25	14.5	19	77-98
U-T122	26	14	21	99-122
U-T154	28	17	25	123-154

Modle	Dimensions(mm)			Conductor Cross-section (mm ²)
	L	B	H	
U-T190	35	17	25	155-190
U-T240	40	20	29	191-240
U-T288	45	22	32	241-288
U-T365	50	27.5	34	289-365
U-T450	60	28	41	366-450

Bolted type connector



WCJG-H

WCJG-T

WCJE

CER

WCJG-H	WCJG-T	WCJE	CER
10-50	10-50	10-50	12mm, 14mm
25-120	25-120	16-95	16mm, 18mm

Din joint



GTD

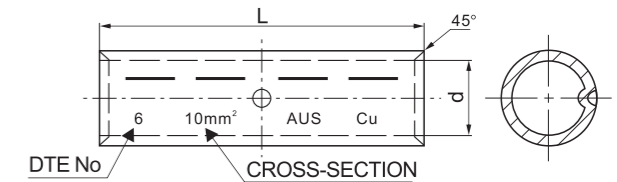

Material: E-Cu
 Surface treatment: Tin-plated mini 8 microns
 Product property: It is in accordance with DIN46267 with markings for correct crimping. To be used for installation LV cables. And its type test is follow IEC 61238-1.

Modle	Dimensions(mm)	
	L	d
GTD-6	30	3.8
GTD-10	30	4.5
GTD-16	50	5.5
GTD-25	50	7
GTD-35	50	8.2
GTD-50	56	10
GTD-70	56	11.5
GTD-95	70	13.5
GTD-120	70	15.5

Modle	Dimensions(mm)	
	L	d
GTD-150	80	17
GTD-185	85	19
GTD-240	90	21.5
GTD-300	100	24.5
GTD-400	150	27.5
GTD-500	160	31
GTD-630	160	34.5
GTD-800	200	40
GTD-1000	200	44

Cable link



GTY-1

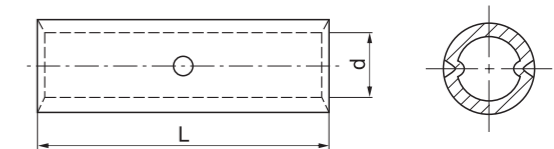

Material: E-Cu
 Surface treatment: Tin-plated
 Product property: It is used to connect copper conductor joint.

Modle	Dimensions(mm)	
	L	d
GTY-1-1.5	20	1.9
GTY-1-2.5	20	2.8
GTY-1-4	20	3.2
GTY-1-6	25	3.7
GTY-1-10	30	4.5
GTY-1-16	35	5.7
GTY-1-25	40	7.2
GTY-1-35	45	8.5
GTY-1-50	50	9.8
GTY-1-70	55	11.5
GTY-1-95	60	13.7

Modle	Dimensions(mm)	
	L	d
GTY-1-120	65	15
GTY-1-150	70	16.7
GTY-1-185	75	19.2
GTY-1-240	80	21
GTY-1-300	85	24
GTY-1-400	90	27
GTY-1-500	100	30
GTY-1-630	110	35
GTY-1-800	150	39
GTY-1-1000	170	44

Cable link



GTY-2

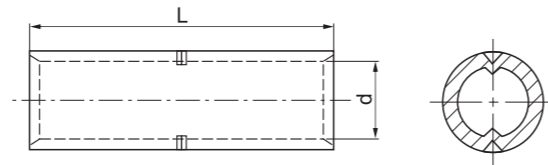

Material: E-Cu
 Surface treatment: Tin-plated
 Product property: It is used to connect copper conductor.

Modle	Dimensions(mm)	
	L	d
GTY-2-1.5	20	1.9
GTY-2-2.5	20	2.8
GTY-2-4	20	3.2
GTY-2-6	25	3.7
GTY-2-10	30	4.5
GTY-2-16	35	5.7
GTY-2-25	40	7.2
GTY-2-35	45	8.5
GTY-2-50	50	9.8
GTY-2-70	55	11.5
GTY-2-95	60	13.7

Modle	Dimensions(mm)	
	L	d
GTY-2-120	65	15
GTY-2-150	70	16.7
GTY-2-185	75	19.2
GTY-2-240	80	21
GTY-2-300	85	24
GTY-2-400	90	27
GTY-2-500	100	30
GTY-2-630	110	35
GTY-2-800	150	39
GTY-2-1000	170	44

Mechanical Lugs and Connectors



AMB

Characteristics:

1. Total cross-section: 25-400 mm
2. Pr-engineered design for perfect fit in medium voltage cable accessories up to 42 kV.
3. Lugs are suitable for out door and indoor applications.
4. Connector and lug bodies are made of a high-tensile, tinplate aluminium alloy.
5. Connection between copper and aluminium conductors is possible.
6. Also available without wire stop, part number with "U".

Nominal Cross section(mm ²)	Code	Dimension (mm)			Bolt Quantity
25-95	AMB25/95	24	65	13	2
35-150	AMB35/150	28	80	16	2
95-240	AMB95/240	33	125	19	4
120-300	AMB120/300	37	140	24	4
185-400	AMB185/400	42	170	24	6

Bimetal link

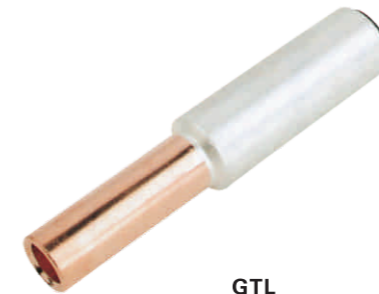

GTL

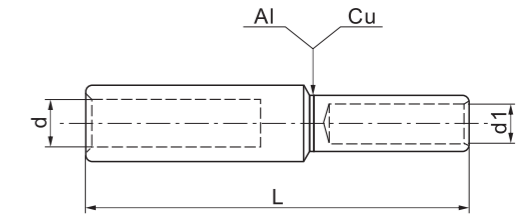

Material: E-Cu; Al-99.6%
 Surface treatment: Bright
 Product property: Due to the coupling effect when Aluminium comes in contact with Copper, corrosion will happen in a short time. Currently the best solution is to use Aluminium-Copper bimetal connectors. A bimetal link should be used for joint. The friction welding is well done. And its aluminium barrel capped is filled with joint compound to avoid oxidization.

Modle	Dimensions(mm)		
	L	d	d1
GTL-AL25/CU16	70	6.8	5.5
GTL-AL35/CU16	76	8	5.5
GTL-AL35/CU25	82	8	7
GTL-AL50/CU25	85	9.8	7
GTL-AL50/CU35	90	9.8	8.2
GTL-AL70/CU35	95	11.2	8.2
GTL-AL70/CU50	100	11.2	10
GTL-AL95/CU50	105	13.2	10
GTL-AL95/CU70	110	13.2	11.5
GTL-AL120/CU70	116	14.7	11.5

Modle	Dimensions(mm)		
	L	d	d1
GTL-AL120/CU95	118	14.7	13.5
GTL-AL150/CU95	120	16.3	13.5
GTL-AL150/CU120	122	16.3	15.5
GTL-AL185/CU120	128	18.3	15.5
GTL-AL185/CU150	130	18.3	17
GTL-AL240/CU150	132	21	17
GTL-AL240/CU185	135	21	19
GTL-AL240/CU240	140	21	21.5
GTL-AL300/CU240	145	23.3	21.5
GTL-AL300/CU300	150	23.3	24.5

Bimetal pin

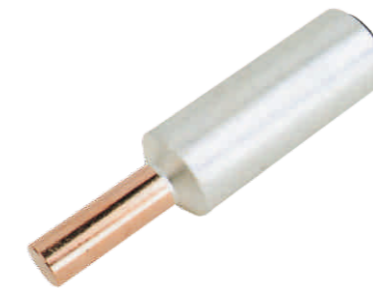

GTLZ

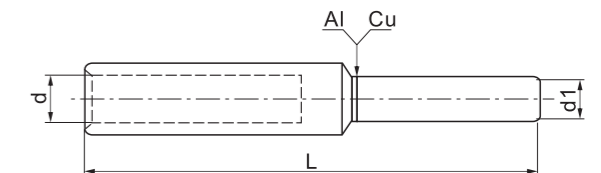

Material: E-Cu; Al-99.6%
 Surface treatment: Bright
 Product property: It is used for non-tension aluminium connection in copper clamp. With markings for correct crimping. Friction welding is well done. The aluminium barrel capped is filled with joint compound to avoid oxidization.

Modle	Dimensions(mm)		
	L	d	d1
GTLZ-25	58	6.8	6
GTLZ-35	71	8	7
GTLZ-50	74	10	8
GTLZ-70	87	11.5	10
GTLZ-95	91	13.2	12

Modle	Dimensions(mm)		
	L	d	d1
GTLZ-120	97	15	12
GTLZ-150	108	16.5	12
GTLZ-185	116	18.5	14
GTLZ-240	128	21.5	16
GTLZ-300	131	23.3	18



D
TOOLS

SDP1



SJMH



SJBCK



SJG



SDSFP



SPI



SJP



SJC



SCT



SZUN

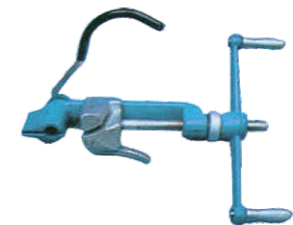

Types HP-70/70C

**液压压接钳
Hydraulic Crimping Tools**

1. 电力电缆导线用油压式压接，紧密导电良好，不容易脱落与导热。
2. 开口式设计，使用方便。
3. 压接头部可以自由旋转180度，可在较窄地方工作。
4. 内置调压阀，当压力达到设定最大压力时自动泄压，防止工具过压。(HP-70C)
5. 标准配置六角型压模七组：4、6、10、16、25、35、50、70
6. 包装方式采用美观实用的一体成型塑料盒。

1. The compression pliers are designed for hydraulic crimping on power cable and wire. The crimped conductor is tested in high conductivity and close contact so that it's uneasy to break out and turn hot.
2. Open cut design for convenient operation.
3. The head could be rotated 180° freely for narrow space working.
4. Fitted with safety valve. When pressure reaches to limited max. Value, pressure release automatically to prevent over pressure.(HP-70C)
5. Standard seven sets of die assembling: 4、6、10、16、25、35、50、70
6. Packing case is made from robust integral plastic box.

Specifications

- 出力Output 5T
- 压接能力Contact Mould 4-70mm²
- 行程Ram Stroke 12mm
- 尺寸Size 305×100×55mm
- 重量Weight 1.6kg

Type HP-120C

**液压压接钳
Hydraulic Crimping Tools**

1. 电力电缆导线用油压式压接，紧密导电良好，不容易脱落与导热。
2. 开口式设计，使用方便。
3. 双速装置将压模快速送到压接管，压接力上升，然后自动转换到低速，在完成压接过程中既省时又省力。
4. 压接头部可以自由旋转180度，可在较窄地方工作。
5. 内置调压阀，当压力达到设定最大压力时自动泄压，防止工具过压。
6. 标准配置六角型压模八组：10、16、25、35、50、70、95、120
7. 包装方式采用美观实用的一体成型塑料盒。

1. The compression pliers are designed for hydraulic crimping on power cable and wire. The crimped conductor is tested in high conductivity and close contact so that it's uneasy to break out and turn hot.
2. Open cut design for convenient operation.
3. Dies are quickly put on tube by double speed unit. Then compression force lift and automatically change to low speed. The operation finishes with energy saving and time shorten.
4. The head could be rotated 180° freely for narrow space working.
5. Fitted with safety valve. When pressure reaches to limited max. Value, pressure release automatically to prevent over pressure.
6. Standard eight sets of die assembling: 10、16、25、35、50、70、95、120
7. Packing case is made from robust integral plastic box.

Specifications

- 出力Output 5T
- 压接能力Contact Mould 10-120mm²
- 行程Ram Stroke 16mm
- 尺寸Size 415×125×65mm
- 重量Weight 2.8kg

Types HP-240C/300C

**液压压接钳
Hydraulic Crimping Tools**

1. 电力电缆导线用油压式压接，紧密导电良好，不容易脱落与导热。
2. 开口式设计，使用方便。
3. 双速装置将压模快速送到压接管，压接力上升，然后自动转换到低速，在完成压接过程中既省时又省力。
4. 压接头部可以自由旋转180度，可在较窄地方工作。
5. 内置调压阀，当压力达到设定最大压力时自动泄压，防止工具过压。
6. 标准配置六角型压模：
HP-240C(十组): 16、25、35、50、70、95、120、150、185、240
HP-300C(十一组): 16、25、35、50、70、95、120、150、185、240、300
7. 包装方式采用美观实用的一体成型塑料盒。

1. The compression pliers are designed for hydraulic crimping on power cable and wire. The crimped conductor is tested in high conductivity and close contact so that it's uneasy to break out and turn hot.
2. Open cut design for convenient operation.
3. Dies are quickly put on tube by double speed unit. Then compression force lift and automatically change to low speed. The operation finishes with energy saving and time shorten.
4. The head could be rotated 180° freely for narrow space working.
5. Fitted with safety valve. When pressure reaches to limited max. Value, pressure release automatically to prevent over pressure.
6. Standard assembling hexagon crimping dies:
HP-240C(10 sets of dies): 16、25、35、50、70、95、120、150、185、240
HP-300C(11 sets of dies): 16、25、35、50、70、95、120、150、185、240、300
7. Packing case is made from robust integral plastic box.

Specifications

- 型号Model HP-240C
- 出力Output 12T
- 压接能力Contact Mould 16-240mm²
- 行程Ram Stroke 25mm
- 尺寸Size 505×125×65mm
- 重量Weight 4.8kg
- 型号Model HP-300C
- 出力Output 8T
- 压接能力Contact Mould 10-120mm²
- 行程Ram Stroke 16mm
- 尺寸Size 505×125×80mm
- 重量Weight 4.2kg

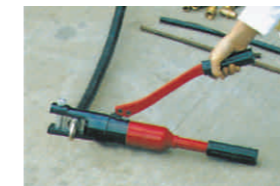
**Types YQ-120
HP-120/120B**

**液压压接钳
Hydraulic Crimping Tools**

1. 电力电缆导线用油压式压接，紧密导电良好，不容易脱落与导热。
2. 双速装置将压模快速送到压接管，压接力上升，然后自动转换到低速，在完成压接过程中既省时又省力。
3. 内置调压阀，当压力达到设定最大压力时自动泄压，防止工具过压。
4. 标准配置六角型压模八组：10、16、25、35、50、70、95、120
5. 包装方式采用美观实用的一体成型塑料盒。

1. The compression pliers are designed for hydraulic crimping on power cable and wire. The crimped conductor is tested in high conductivity and close contact so that it's uneasy to break out and turn hot.
2. Dies are quickly put on tube by double speed unit. Then compression force lift and automatically change to low speed. The operation finishes with energy saving and time shorten.
3. Fitted with safety valve. When pressure reaches to limited max. Value, pressure release automatically to prevent over pressure.
4. Standard eight sets of die assembling: 10、16、25、35、50、70、95、120
5. Packing case is made from robust integral plastic box.

Specifications

型号 Modle	出力 Output (T)	压接能力 Contact Mould (mm ²)	行程 Ram Stroke (mm)	尺寸 Size (mm)	重量 Weight (kg)
YQ-120	8	10-120	14	415×126×65	3.0
HP-120(双速)	8	10-120	14	415×126×65	3.0
HP-120B(双速, 安全装置)	8	10-120	14	415×126×65	3.1

**Types YQ-240/300
HP-240/300/300B**

**液压压接钳
Hydraulic Crimping Tools**

1. 电力电缆导线用油压式压接，紧密导电良好，不容易脱落与导热。
2. 双速装置将压模快速送到压接管，压接力上升，然后自动转换到低速，在完成压接过程中既省时又省力。
3. 内置调压阀，当压力达到设定最大压力时自动泄压，防止工具过压。
4. 标准配置七角型压模八组：16、25、35、50、70、95、120、150、185、240、(300)
5. 包装方式采用美观实用的一体成型塑料盒。

1. The compression pliers are designed for hydraulic crimping on power cable and wire. The crimped conductor is tested in high conductivity and close contact so that it's uneasy to break out and turn hot.
2. Dies are quickly put on tube by double speed unit. Then compression force lift and automatically change to low speed. The operation finishes with energy saving and time shorten.
3. Fitted with safety valve. When pressure reaches to limited max. Value, pressure release automatically to prevent over pressure.
4. Standard eleven sets of die assembling: 16、25、35、50、70、95、120、150、185、240、(300)
5. Packing case is made from robust integral plastic box.

Specifications

型号 Modle	出力 Output (T)	压接能力 Contact Mould (mm ²)	行程 Ram Stroke (mm)	尺寸 Size (mm)	重量 Weight (kg)
YQ-240	12	10-240	18	490×130×70	3.8
YQ-300	12	16-300	18	490×130×70	3.9
HP-240(双速)	12	16-240	18	490×130×70	3.8
HP-300(双速)	12	16-300	18	490×130×70	3.9
HP-300B(双速, 安全装置)	12	16-300	18	490×130×70	4.0

Type CYO-410

**液压压接钳
Hydraulic Crimping Tools**

1. 电力电缆导线用油压式压接，紧密导电良好，不容易脱落与导热。
2. 开口式设计，使用方便。
3. 双速装置将压模快速送到压接管，压接力上升，然后自动转换到低速，在完成压接过程中既省时又省力。
4. 压接头部可以自由旋转180度，可在较窄地方工作。
5. 内置调压阀，当压力达到设定最大压力时自动泄压，防止工具过压。
6. 标准配置六角型压模九组：35、50、70、95、120、150、185、240、300
7. 玻璃纤维操作绝缘棒，可以防止意外电击。
8. 包装方式采用美观实用的一体成型塑料盒。

1. The compression pliers are designed for hydraulic crimping on power cable and wire. The crimped conductor is tested in high conductivity and close contact so that it's uneasy to break out and turn hot.
2. Open cut design for convenient operation.
3. Dies are quickly put on tube by double speed unit. Then compression force lift and automatically change to low speed. The operation finishes with energy saving and time shorten.
4. The head could be rotated 180° freely for narrow space working.
5. Fitted with safety valve. When pressure reaches to limited max. Value, pressure release automatically to prevent over pressure.
6. Standard nine sets of die assembling: 35、50、70、95、120、150、185、240、300
7. Fiberglass insulated handles to prevent accidental electric Hitting.
8. Packing case is made from robust integral plastic box.

Specifications

- 出力 Output 12T
- 压接能力 Contact Mould 35-300mm²
- 行程 Ram Stroke 30mm
- 尺寸 Size 620×160×70mm
- 重量 Weight 6.5kg

Type CYO-430

**液压压接钳
Hydraulic Crimping Tools**

1. 电力电缆导线用油压式压接，紧密导电良好，不容易脱落与导热。
2. 开口式设计，使用方便。
3. 双速装置将压模快速送到压接管，压接力上升，然后自动转换到低速，在完成压接过程中既省时又省力。
4. 压接头部可以自由旋转180度，可在较窄地方工作。
5. 内置调压阀，当压力达到设定最大压力时自动泄压，防止工具过压。
6. CYO-430标准配置六角型压模九组：50、70、95、120、150、185、240、300、400
7. 玻璃纤维操作绝缘棒，可以防止意外电击。
8. 包装方式采用美观实用的一体成型塑料盒。

1. The compression pliers are designed for hydraulic crimping on power cable and wire. The crimped conductor is tested in high conductivity and close contact so that it's uneasy to break out and turn hot.
2. Open cut design for convenient operation.
3. Dies are quickly put on tube by double speed unit. Then compression force lift and automatically change to low speed. The operation finishes with energy saving and time shorten.
4. The head could be rotated 180° freely for narrow space working.
5. Fitted with safety valve. When pressure reaches to limited max. Value, pressure release automatically to prevent over pressure.
6. CYO-430 Standard nine sets of die assembling: 50、70、95、120、150、185、240、300、400
7. Fiberglass insulated handles to prevent accidental electric Hitting.
8. Packing case is made from robust integral plastic box.

Specifications

- 出力 Output 12T
- 压接能力 Contact Mould 35-300mm²
- 行程 Ram Stroke 30mm
- 尺寸 Size 620×160×70mm
- 重量 Weight 6.5kg

Type CYO-510B

**液压压接钳
Hydraulic Crimping Tools**

1. 电力电缆导线用油压式压接，紧密导电良好，不容易脱落与导热。
2. 开口式设计，使用方便。
3. 双速装置将压模快速送到压接管，压接力上升，然后自动转换到低速，在完成压接过程中既省时又省力。
4. 压接头部可以自由旋转180度，可在较窄地方工作。
5. 内置调压阀，当压力达到设定最大压力时自动泄压，防止工具过压。
6. CYO-510B标准配置六角型压模九组：50、70、95、120、150、185、240、300、400
7. 玻璃纤维操作绝缘棒，可以防止意外电击。
8. 包装方式采用美观实用的一体成型塑料盒。

1. The compression pliers are designed for hydraulic crimping on power cable and wire. The crimped conductor is tested in high conductivity and close contact so that it's uneasy to break out and turn hot.
2. Open cut design for convenient operation.
3. Dies are quickly put on tube by double speed unit. Then compression force lift and automatically change to low speed. The operation finishes with energy saving and time shorten.
4. The head could be rotated 180° freely for narrow space working.
5. Fitted with safety valve. When pressure reaches to limited max. Value, pressure release automatically to prevent over pressure.
6. CYO-510B Standard nine sets of die assembling: 50、70、95、120、150、185、240、300、400
7. Fiberglass insulated handles to prevent accidental electric Hitting.
8. Packing case is made from robust integral plastic box.

Specifications

- 出力 Output 13T
- 压接能力 Contact Mould 50-400mm²
- 行程 Ram Stroke 38mm
- 尺寸 Size 650×150×70mm
- 重量 Weight 7.2kg

Type KYQ-300

**液压压接钳
Hydraulic Crimping Tools**

1. 电力电缆导线用油压式压接，紧密导电良好，不容易脱落与导热。
2. 开口式设计，使用方便。
3. 双速装置将压模快速送到压接管，压接力上升，然后自动转换到低速，在完成压接过程中既省时又省力。
4. 内置调压阀，当压力达到设定最大压力时自动泄压，防止工具过压。
5. 标准配置六角型压模八组：16、25、35、50、70、95、120、150、185、240、300
6. 包装方式采用美观实用的一体成型塑料盒。

1. The compression pliers are designed for hydraulic crimping on power cable and wire. The crimped conductor is tested in high conductivity and close contact so that it's uneasy to break out and turn hot.
2. Open cut design for convenient operation.
3. Dies are quickly put on tube by double speed unit. Then compression force lift and automatically change to low speed. The operation finishes with energy saving and time shorten.
4. Fitted with safety valve. When pressure reaches to limited max. Value, pressure release automatically to prevent over pressure.
5. Standard eleven sets of die assembling: 16、25、35、50、70、95、120、150、185、240、300
6. Packing case is made from robust integral plastic box.

Specifications

- 出力 Output 12T
- 压接能力 Contact Mould 16-240mm²
- 行程 Ram Stroke 25mm
- 尺寸 Size 520×145×80mm
- 重量 Weight 7.0kg

Types HX-50B/50SC/50D

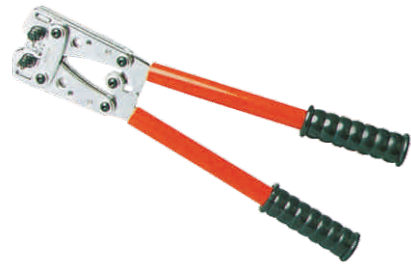

强力六角围压压接钳
Heavy-duty Hexagon Crimping Pliers

1.裸端子专用(压后呈六角形)
2.压接钳用于非焊接的,符合标准的电气连接,精密的口模材质为SCM-40超硬工具钢制造而成,寿命特长,孔径尺寸精确,压著效果佳。

1.For non-insulated cable links
2.The crimping tools is used for non-welding and standard electrical connection. The mould of jaw is made of SCM-40 hardest tool steel. It is with the characteristics of long life, accurate bore diameter and good crimping effect.

Specifications

- 应用范围
Range of Application
Y.O 裸端子
Non-insulated cable links
- 压接能力
Capacity
6-50mm²
- 长度
Length
390mm
- 重量
Weight
1.3kg

Types HX-120B/120BT/120BX



HX-120BT

HX-120BX

强力六角围压压接钳
Heavy-duty Hexagon Crimping Pliers

1.裸端子专用(压后呈六角形)
2.压接钳用于非焊接的,符合标准的电气连接,精密的口模材质为SCM-40超硬工具钢制造而成,寿命特长,孔径尺寸精确,压著效果佳。
3.伸缩式手柄/双接式手柄。

1.For non-insulated cable links
2.The crimping tools is used for non-welding and standard electrical connection. The mould of jaw is made of SCM-40 hardest tool steel. It is with the characteristics of long life, accurate bore diameter and good crimping effect.
3.Extendable handles/ScREWED-off handles.

Specifications

- 应用范围
Range of Application
Y.O 裸端子
Non-insulated cable links
- 压接能力
Capacity
HX-120B 10-120mm²
HX-120SC 25-150mm²
HX-120A 16-120mm²
- 长度
Length
620mm
- 重量
Weight
4.0kg

Types HX-150B/150BX



强力六角围压压接钳
Heavy-duty Hexagon Crimping Pliers

1.裸端子专用(压后呈六角形)
2.压接钳用于非焊接的,符合标准的电气连接,精密的口模材质为SCM-40超硬工具钢制造而成,寿命特长,孔径尺寸精确,压著效果佳。
3.伸缩式手柄。

1.For non-insulated cable links
2.The crimping tools is used for non-welding and standard electrical connection. The mould of jaw is made of SCM-40 hardest tool steel. It is with the characteristics of long life, accurate bore diameter and good crimping effect.
3.Extendable handles.

Specifications

- 应用范围
Range of Application
非绝缘端子和连接头
Non-insulated cable links
- 压接能力
Capacity
16-150mm²
- 长度
Length
620mm
- 重量
Weight
4.0kg

Type HX-245B



强力六角围压压接钳
Heavy-duty Hexagon Crimping Pliers

1.裸端子专用(压后呈六角形)
2.压接钳用于非焊接的,符合标准的电气连接,精密的口模材质为SCM-40超硬工具钢制造而成,寿命特长,孔径尺寸精确,压著效果佳。
3.伸缩式手柄。

1.For non-insulated cable links
2.The crimping tools is used for non-welding and standard electrical connection. The mould of jaw is made of SCM-40 hardest tool steel. It is with the characteristics of long life, accurate bore diameter and good crimping effect.
3.Extendable handles.

Specifications

- 应用范围
Range of Application
非绝缘端子和连接头
Non-insulated cable links
- 压接能力
Capacity
70-240mm²
- 长度
Length
980mm
- 重量
Weight
5.6kg

Type CC-100L



省力长臂电缆剪
Energy Saving Calbe Cutter with Long Arm

- 锻造刀刃,寿命长,剪切容易
- 高强度铝合金手柄
- 注意不能用于剪切钢丝绳和铜硬拉线
- 剪切范围: 100mm²以下
- Forged knife edge for long shelf life and easy cutting.
- High strength Al Alloy handles.
- Note: Cutting steel rope and hard drawn copper wires are prohibited.
- Cutting range: 100mm² or below.

Specifications

- 长度 Length
280mm
- 重量 Weight
0.6kg

Type CC-250L



省力长臂电缆剪
Energy Saving Calbe Cutter with Long Arm

- 锻造刀刃,寿命长,剪切容易
- 高强度铝合金手柄
- 注意不能用于剪切钢丝绳和铜硬拉线
- 剪切范围: 250mm²以下
- Forged knife edge for long shelf life and easy cutting.
- High strength Al Alloy handles.
- Note: Cutting steel rope and hard drawn copper wires are prohibited.
- Cutting range: 250mm² or below.

Specifications

- 长度 Length
600mm
- 重量 Weight
1.7kg

Type CC-500L



省力长臂电缆剪
Energy Saving Calbe Cutter with Long Arm

- 锻造刀刃,寿命长,剪切容易
- 高强度铝合金手柄
- 注意不能用于剪切钢丝绳和铜硬拉线
- 剪切范围: 500mm²以下
- Forged knife edge for long shelf life and easy cutting.
- High strength Al Alloy handles.
- Note: Cutting steel rope and hard drawn copper wires are prohibited.
- Cutting range: 500mm² or below.

Specifications

- 长度 Length
810mm
- 重量 Weight
2.76kg

Type CC-325



**棘轮式剪刀
Ratchet Cutter**

- 附棘轮装置剪切时省力
- 注意不能用于剪切钢丝绳和铜硬拉线
- 锻造式刀刃，寿命长
- 附安全锁扣
- Fitted with ratcheting unit for energy saving cutting.
- Note: Cutting steel rope and hard-drawn copper wire are prohibited.
- Forged knife edge for long shelf life.
- Fitted with safety lock.

Specifications

- 应用范围 Range of Application Cutting Cu-Al cable below 240mm² 以下
- 切断能力面积 Cutting capacity 240mm² 以下
- 长度 Length 260mm
- 重量 Weight 0.7kg

Type CC-520



**棘轮式剪刀
Ratchet Cutter**

- 附棘轮装置剪切时省力
- 注意不能用于剪切钢丝绳和铜硬拉线
- 锻造式刀刃，寿命长
- 附安全锁扣
- Fitted with ratcheting unit for energy saving cutting.
- Note: Cutting steel rope and hard-drawn copper wire are prohibited.
- Forged knife edge for long shelf life.
- Fitted with safety lock.

Specifications

- 应用范围 Range of Application Cutting Cu-Al cable below 400mm² 以下
- 切断能力面积 Cutting capacity 400mm² 以下
- 长度 Length 320mm
- 重量 Weight 1.0kg

Type XLG-D-500

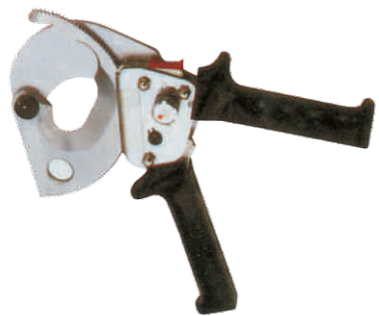

**棘轮式剪刀
Ratchet Cutter**

- 锻造刀刃，寿命长，剪切容易
- 体积小、重量轻
- 手柄可伸长
- 脱扣方便，中途可退刀
- 注意不能用于剪切钢丝绳和铜硬拉线
- Forged knife edge for long shelf life and easy cutting.
- Compact and light for easy carrying.
- Handles extendable.
- Easy release and could stop at any position.
- Note: Cutting steel rope and hard-drawn copper wire is strictly prohibited.

Specifications

- 应用范围 Range of Application Cutting Cu-Al cable below 400mm² 以下
- 切断能力面积 Cutting capacity $\phi 40$ 或500mm² 以下
- 长度 Length 240mm(伸Extend 290mm)
- 重量 Weight 1.1kg

Type XLG-D-500B



**棘轮式剪刀
Ratchet Cutter**

- 锻造刀刃，寿命长，剪切容易
- 体积小、重量轻
- 手柄可伸长
- 脱扣方便，中途可退刀
- 剪切范围大
- Forged knife edge for long shelf life and easy cutting.
- Compact and light for easy carrying.
- Handles extendable.
- Easy release and could stop at any position.
- Larger cutting scope are available.

Specifications

- 应用范围 Range of Application 铜铝电线缆
- 切断能力面积 Cutting capacity 600mm² 以下钢芯铝绞线的切断 Cutting Al cable steel reinforced below 600mm²
- $\phi 32$ 以下钢芯电缆的切断 Steel-cored cable below $\phi 32$ mm
- 100mm² 以下钢绞线的切断 Steel stranded wire below 100mm²
- $\phi 12$ 以下钢筋的切断 Bar steel below $\phi 12$ mm
- 长度 Length: 235mm
- 重量 Weight: 1.1kg

Type XLJ-65A



棘轮式剪刀 Ratchet Cutter

- 锻造刀刃，寿命长，剪切容易
- 手柄可伸长
- 脱扣方便，中途可退刀
- 在剪切过程中，若要退刀，可将活动手柄锁紧后顶住撑齿块，此时握活动手柄的手松开，逆时针移动旋转刀板。
- 注意不能用于剪切钢索、钢筋

- Forged knife edge for long shelf life and easy cutting.
- Compact and light for easy carrying.
- Easy release and could stop at any position.
- If knife return is necessary during cutting, let the movable handlelock and against the prop tooth block, then loosen the hand which gripes the handle, turn the swivel knife in counter clockwise.
- Note: Cutting steel rope and steel bar is strictly prohibited.

Types XLJ-95A/120A/160A

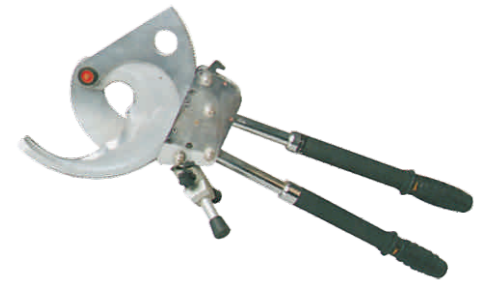

技术参数 Specification			
型号 Modle	应用范围 Range of Application	长度 Length	重量 Weight
XLJ-65A	$\phi 65$ 以下铜、铝铠装电缆的切断 Cutting Cu-Al cable below $\phi 65$	355mm(伸Extend 435mm)	3.0kg
XLJ-95A	$\phi 95$ 以下铜、铝铠装电缆的切断 Cutting Cu-Al cable below $\phi 95$	530mm(伸Extend 725mm)	6.3kg
XLJ-120A	$\phi 120$ 以下铜、铝铠装电缆的切断 Cutting Cu-Al cable below $\phi 120$	555mm(伸Extend 745mm)	7.0kg
XLJ-160A	$\phi 160$ 以下铜、铝铠装电缆的切断 Cutting Cu-Al cable below $\phi 160$	760mm(伸Extend 950mm)	9.5kg

棘轮式剪刀 Ratchet Cutter

- 锻造刀刃，寿命长，剪切容易
- 手柄可伸长
- 脱扣方便，中途可退刀
- 在剪切过程中，若要退刀，可将活动手柄锁紧后顶住撑齿块，此时握活动手柄的手松开，逆时针移动旋转刀板。
- 刀片可修磨、互换。
- XLJ-G-40W 刀片采用硬质合金材料，耐磨性能好，使用寿命长。
- 注意不能用于剪切钢索、钢筋

- Forged knife edge for long shelf life and easy cutting.
- Compact and light for easy carrying.
- Easy release and could stop at any position.
- If knife return is necessary during cutting, let the movable handlelock and against the prop tooth block, then loosen the hand which gripes the handle, turn the swivel knife in counter clockwise.
- Knives are resharpening or exchangeable.
- The knife of XLJ-G-40W is made of alloy steel, good performance of wear resistance, long useful life.
- Note: Cutting steel rope and steel bar is strictly prohibited.

Types XLJ-G-40/40A/40W

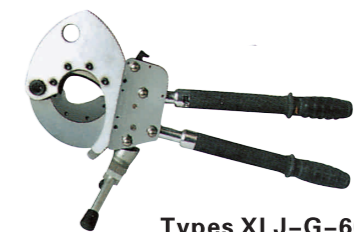

Types XLJ-G-60/60A

型号 Modle	应用范围 Range of Application	长度 Length	重量 Weight
XLJ-G-40	120mm ² 以下钢绞线的切断，800mm ² 以下钢芯铝绞线的切断 $\phi 36$ 以下钢芯电缆的切断， $\phi 14$ 以下低碳钢的切断 Cutting steel stranded wire below 120mm ² , Al cable steel reinforced below 800mm ² Cutting steel-cored cable below $\phi 36$ mm, Low carbon steel bar below $\phi 14$ mm	440mm(伸Extend 630mm)	3.6kg
XLJ-G-40A	$\phi 20$ 以下钢丝绳的切断， $\phi 36$ 以下铝钢电缆的切断 Cutting steel wire rope below $\phi 20$ mm ² , cutting Cu-Al cable below $\phi 36$ mm	440mm(伸Extend 630mm)	3.6kg
XLJ-G-40W	120mm ² 以下钢绞线的切断，800mm ² 以下钢芯铝绞线的切断 $\phi 36$ 以下钢芯电缆的切断， $\phi 14$ 以下低碳钢的切断 Cutting steel stranded wire below 120mm ² , Al cable steel reinforced below 800mm ² Cutting steel-cored cable below $\phi 36$ mm, Low carbon steel bar below $\phi 14$ mm	440mm(伸Extend 630mm)	3.6kg
XLJ-G-60	150mm ² 以下钢绞线的切断，1200mm ² 以下钢芯铝绞线的切断 $\phi 52$ 以下钢芯电缆的切断， $\phi 16$ 以下低碳钢的切断 Cutting steel stranded wire below 150mm ² , Al cable steel reinforced below 1200mm ² Cutting steel-cored cable below $\phi 52$ mm, Low carbon steel bar below $\phi 16$ mm	525mm(伸Extend 715mm)	7.0kg
XLJ-G-60A	$\phi 26$ 以下钢丝绳的切断， $\phi 52$ 以下铝钢电缆的切断 Cutting steel wire rope below $\phi 26$ mm ² , cutting Cu-Al cable below $\phi 52$ mm	525mm(伸Extend 715mm)	7.0kg



FUSE CUTOUT

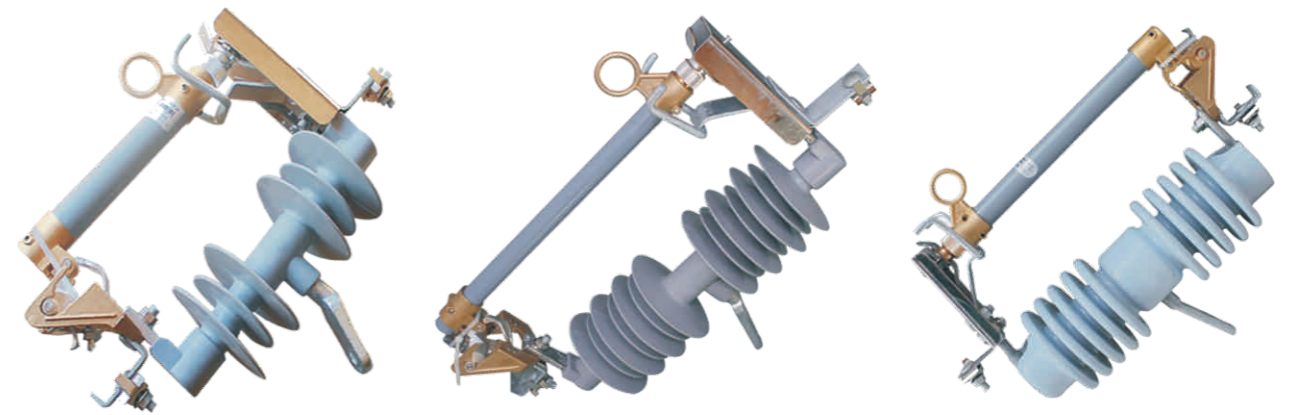

APPLICATION

The primary purpose of any Cut-out Fuse is to provide protection to the lines of your system and the various apparatus on those lines such as transformers and capacitor banks. Cutout fuse provide reliable protection from low-level overloads that just melt the fuse link, intermediate faults, and very high faults, through maximum interrupting capacity.

Technical Data:

Type	Rated Voltage	Rated Current	Breaking Current	Impulse Voltage	Power-frequency withstand voltage	Leakage distance
	(kV)	(A)	(BIL)	(kV)	(mm)	(kg)
SM-1	12	100	6.3	110	40	250
SM-1	12	200	8	110	40	250
SM-2	15	100	10	125	45	320
SM-2	15	200	12	125	45	320
SM-3	24	100	8	150	65	530
SM-3	24	200	10	150	65	530
SM-4	15	100	10	125	45	350
SM-4	15	200	12	125	45	350
SM-5	12	100	6.3	110	40	250
SM-5	12	200	8	110	40	250
SM-6	15	100	10	125	45	320
SM-6	15	200	12	125	45	320
SM-7	24	100	8	150	65	540
SM-7	24	200	10	150	65	540
SM-7(F)	33	200	12	170	70	720
SM-8	33	100	10	170	70	720
SM-8	33	200	12	170	70	720

EXPULSION FUSE LINK



Technical Specification

- Expulsion fuse link for fuse cutout
- Rated voltage: 11KV-36KV
- Rated current: 1A-200A
- Rate of melting: Class K & Class T

Outline Dimension

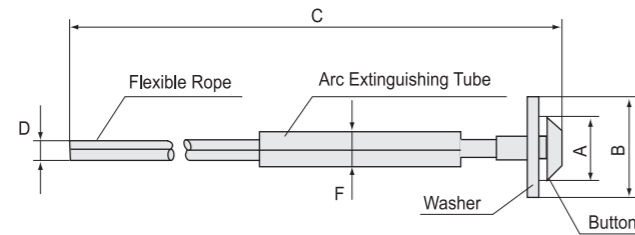

FIXED BUTTON TYPE

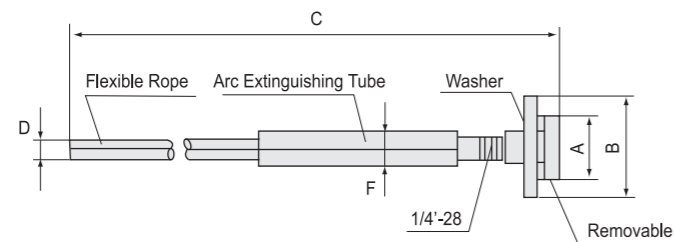

REMOVABLE TYPE

Rated current (A)	Dimension(mm)				
	A	B	C	D	F
1 to 25	12.5± 0.2	19.0± 0.2	533	2.0	6.5
30 to 40	12.5± 0.2	19.0± 0.2	533	3.0	8.0
50 to 100	19.0± 0.3	(Not applicable)	533	5.0	10.0

SUSPENSION COMPOSITE INSULATOR



Type	Rated voltage (KV)	Specified mechanical load	Section length (mm)	Min Arc distance (mm)	Leakage distance (mm)	Lightning impulse withstand BIL(KV)	Power frequency withstand (wet) (KV)
FXBW4-12/70	12	70	350	180	400	95	45
FXBW4-24/70	24	70	550	370	850	185	95
FXBW4-24/100	24	100	570	370	850	185	95
FXBW4-35/70	36	70	650	450	1000	230	105
FXBW4-35/100	36	100	670	450	1000	230	105

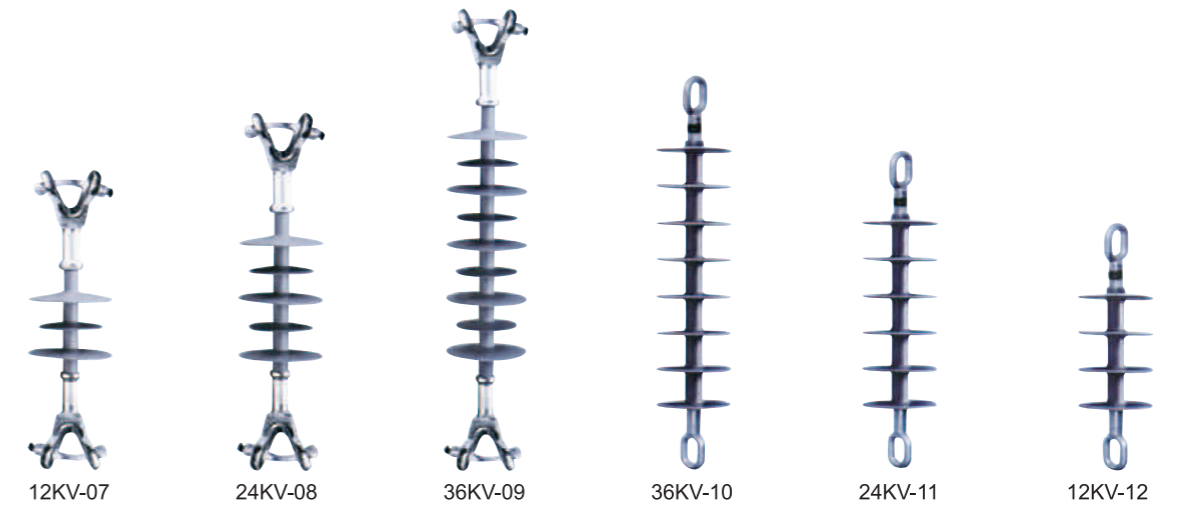

Type	Rated voltage (KV)	Specified mechanical load	Section length (mm)	Min Arc distance (mm)	Leakage distance (mm)	Lightning impulse withstand BIL(KV)	Power frequency withstand (wet) (KV)
FXYW4-12/70	12	70	350	180	400	95	45
FXYW4-24/70	24	70	550	370	850	185	95
FXYW4-24/100	24	100	570	370	850	185	95
FXYW4-35/70	36	70	650	450	1000	230	105
FXYW4-35/100	36	100	670	450	1000	230	105

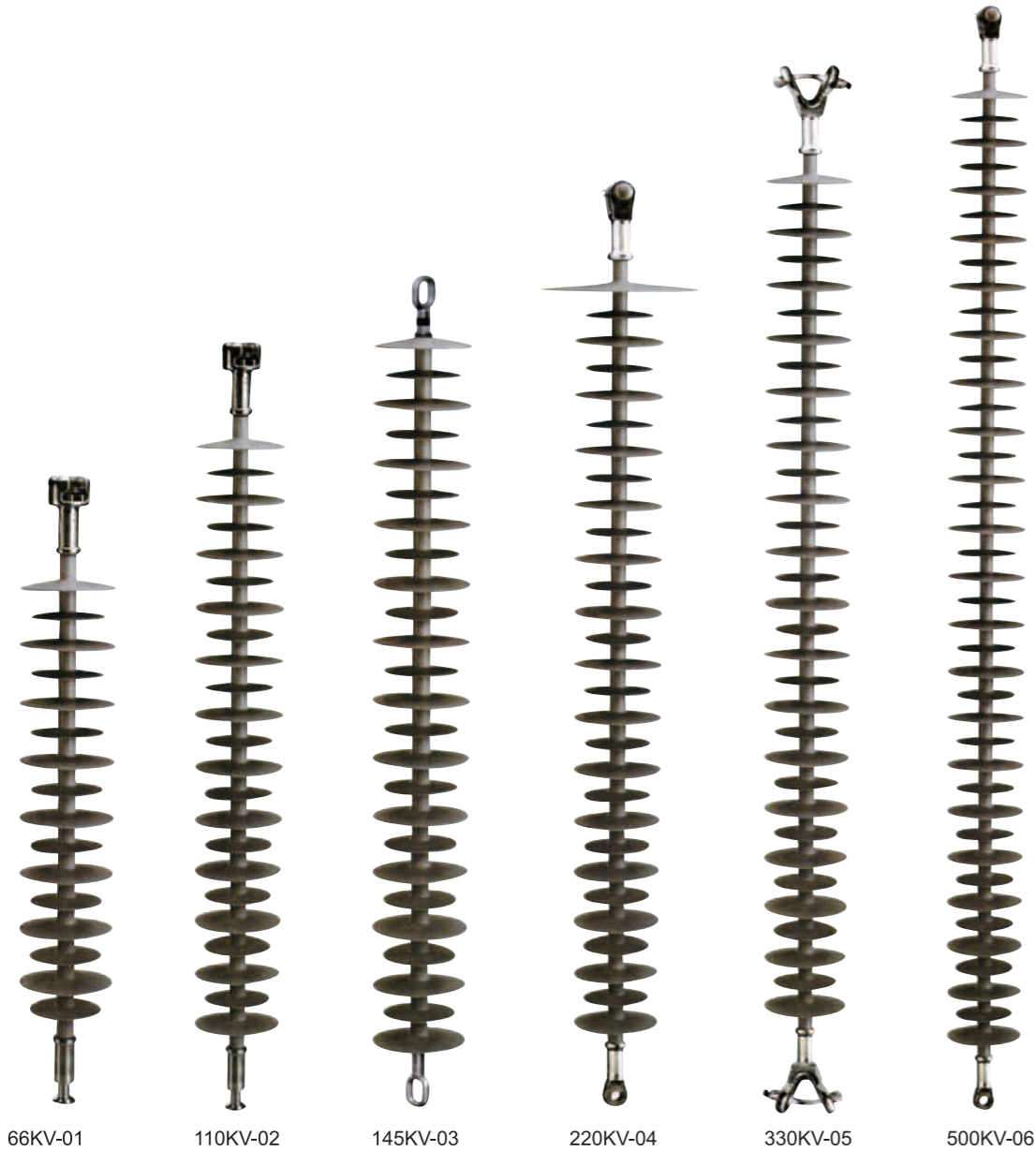
SUSPENSION COMPOSITE INSULATOR

Type	Rated voltage (KV)	Specified mechanical load	Section length (mm)	Min Arc distance (mm)	Leakage distance (mm)	Lightning impulse withstand BIL(KV)	Power frequency withstand (wet) (KV)
FPBW4-66/70	66	70	900	710	1980	410	185
FPBW4-66/100	66	100	940	710	1980	410	185
FPBW4-110/100	110	100	1240	1000	3315	550	230
FPBW4-145/120	145	120	1480	1240	4123	725	355
FPBW4-220/100	220	100	2240	1900	6300	1000	395
FPBW4-220/160	220	160	2240	1900	6300	1000	395
FPBW4-330/100	330	100	2990	2600	9075	1425	570
FPBW4-330/160	330	160	2990	2600	9075	1425	570
FPBW4-500/160	500	160	4080	3730	12750	2250	740

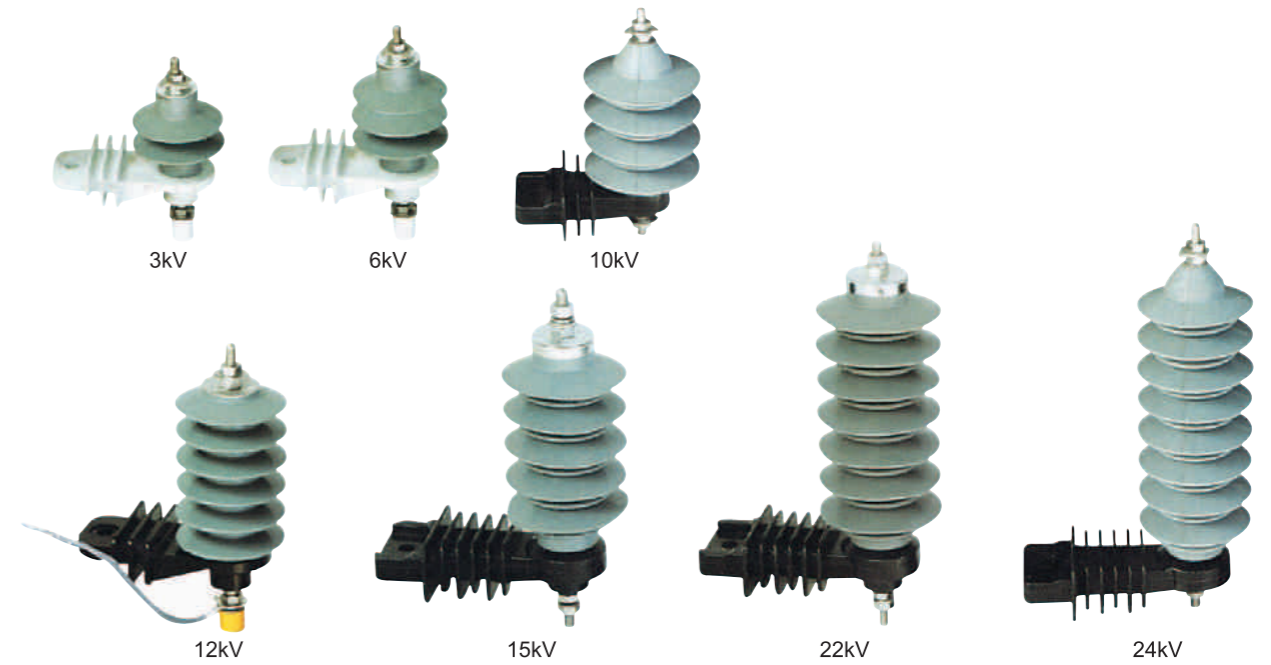

Type	MOA Rated voltage kV(rms)	MCOV kV(rms)	Current impulse Residual Voltage			2ms Rectangular current impulse withstand A(crest)	4/10μ s High current impulse withstand kA(crest)
			1/4μ s Lightning current impulse kV(crest)	8/20μ s Lightning current impulse kV(crest)	30/60μ s Switching current impulse kV(crest)		
YH5W-3	3	2.55	11.3	9	8.9	150	65
YH5W-6	6	5.1	22.6	18	16.8	150	65
YH5W-9	9	7.65	33.7	27	23.8	150	65
YH5W-10	10	8.4	36	30	23	150	65
YH5W-11	11	9.4	40	33	30	150	65
YH5W-12	12	10.2	42.2	36	27	150	65
YH5W-15	15	12.7	51	45	38.5	150	65
YH5W-18	18	15.3	61.5	54	46.2	150	65
YH5W-21	21	17.0	71.8	63	54.2	150	65
YH5W-24	24	19.5	82	72	62	150	65
YH5W-27	27	22.0	92	81	69.8	150	65
YH5W-30	30	24.4	102	90	79	150	65
YH5W-33	33	27.5	112	99	86.7	150	65
YH5W-36	36	29.0	123	108	92.4	150	65

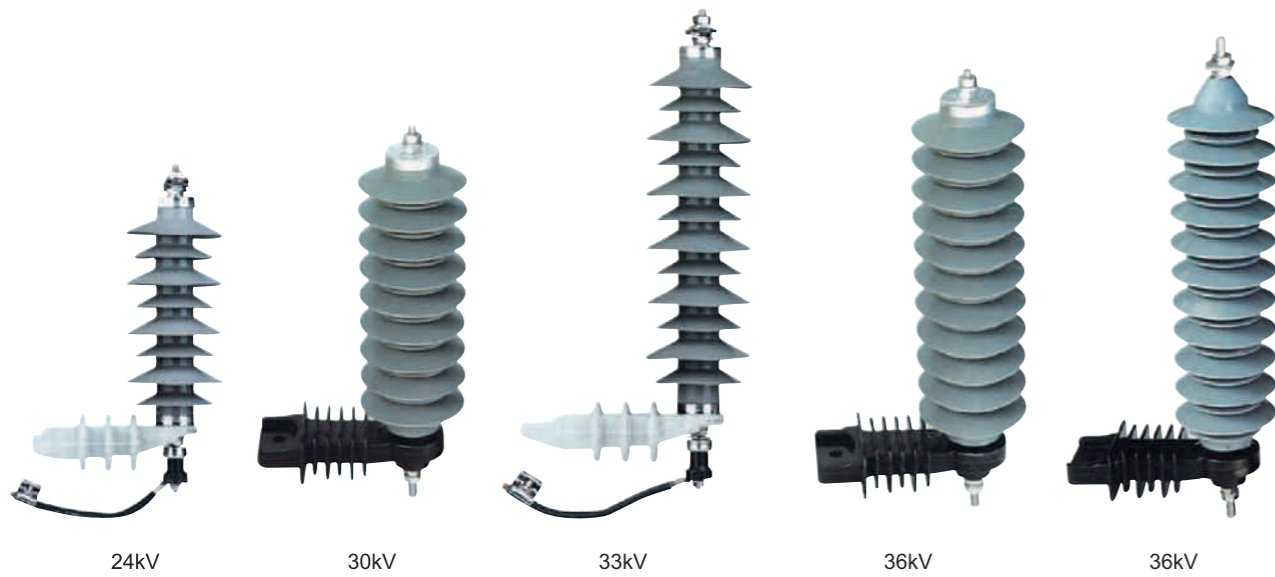

Type	MOA Rated voltage	MCOV	Current impulse residual voltage			2ms Rectangular current impulse withstand	4/10μ s High current impulse withstand
			1/4μ s Lightning current impulse	8/20μ s Lightning current impulse	30/60μ s Switching current impulse		
	kV(rms)	kV(rms)	kV(crest)	kV(crest)	kV(crest)	A(crest)	kA(crest)
YH10W-3	3	2.55	11.3	9	8.9	250	100
YH10W-6	6	5.1	22.6	18	16.8	250	100
YH10W-9	9	7.65	33.7	27	23.8	250	100
YH10W-10	10	8.4	36	30	23	250	100
YH10W-11	11	9.4	40	33	30	250	100
YH10W-12	12	10.2	42.2	36	27	250	100
YH10W-15	15	12.7	51	45	38.5	250	100
YH10W-18	18	15.3	61.5	54	46.2	250	100
YH10W-21	21	17.0	71.8	63	54.2	250	100
YH10W-24	24	19.5	82	72	62	250	100
YH10W-27	27	22.0	92	81	69.8	250	100
YH10W-30	30	24.4	102	90	79	250	100
YH10W-33	33	27.5	112	99	86.7	250	100
YH10W-36	36	29.0	123	108	92.4	250	100

MAJOR ENDUSER

